

## 54D Pneumatic - electronic pressure sensor

- > -1 ... 16 bar, with three pressures ranges
- > Compact, robust and light weight with G1/8 port
- > 2 switching outputs or 1 switching output (IO-Link configurable), 1 analogue (4 ... 20mA)
- > Pressure display colour change configurable at switching point (red/green)
- > High overpressure and vacuum resistance
- > Option for set up as a differential pressure sensor
- > UL-listed



### Technical features

#### Medium:

Compressed air (filtered/lubricated/non-lubricated)

#### Pressure range:

-1 ... 1 bar (-14,5 ... 14,5 psi)  
-1 ... 10 bar (-14,5 ... 145 psi)  
0 ... 16 bar (0 ... 232 psi)

#### Pressure type:

Relative, and option for differential pressure

#### Switching pressure difference:

Programmable

#### Switching point:

Adjustable between  
0 ... 100% of full scale (FS)

#### Reset point:

Adjustable between  
0 ... 100% of full scale (FS)  
(smallest adjustable pressure switching difference between switching point and reset point  $\geq 0,5\%$  of full scale (FS))

### Electronic features

#### Electrical connection:

M8

#### Power supply:

UB = 18 ... 32 VDC  
reverse-polarity protected  
(according to EN 50178 SELV/  
PELV)

#### Permissible residual ripple:

10% (within UB)

#### Current consumption:

< 50 mA

#### Display:

Alphanumeric display, 4-digit (red/green), programmable pressure units: bar, kPa, psi, inHg

#### Mounting position:

Optional

#### Total accuracy:

$\pm 0,5\%$  of full scale (FS) - without temperature sensitivity

#### Linearity:

$\pm 0,25\%$  + 1 display step size

#### Shock proof:

50 g, (11ms), DIN EN 60068-2-27

#### Vibration proof:

20 g, 10 ... 2000 Hz,  
DIN EN 60068-2-6

#### Degree of protection acc.

**DIN EN 60529:**

IP65

#### Switching mode:

PNP

Output signal:

Switching signal; IO-Link  
(configurable)

#### Contact rating:

I<sub>max</sub> VDC = 100 mA

#### Weight:

0,087 kg (0.19 lbs)

#### Temperature sensitivity:

Zero-point:  $\pm 0,2\%$  of maximum operating pressure range (FS) per 10 Kelvin  
Pressure range:  $\pm 0,2\%$  of maximum operating pressure range (FS) per 10 Kelvin (at 0 ... 60°C)

#### Ambient/Media temperature:

Ambient:

0 ... +70°C (+32 ... +158°F)

Media:

0 ... +70°C (+32 ... +158°F)

Air supply must be dry enough to avoid ice formation at temperature below +2°C (+35°F)

#### Materials:

Housing:

PBT, FKM, Polyester

Wetted parts: Brass, FKM, Silicon (coated), PBT

#### Switching time:

< 6 ms

#### Adjustable signal delay dS, dr[s]:

0; 0,002 ... 5

#### Service life:

Min. 50 million switching cycles

#### Switching logic:

NO/NC programmable

#### Operating mode:

Hysteresis and window mode separately selectable for each output

#### Electromagnetic compatibility:

EN 61000-6-2; EN 61000-6-3

### Technical data - Output Signal 2 x PNP

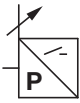
Symbol	Port size	Pressure range (bar)	Pressure range (psi)	Over pressure*1 (bar)	Over pressure*1 (psi)	Type of Pressure	Output Signal	Model
	G1/8	-1 ... 1	-14.5 ... 14.5	20	290	Relative	2 x PNP	54D-V101G-DD0-AA
	G1/8	-1 ... 10	-14,5 ... 145	20	290	Relative	2 x PNP	54D-V110G-DD0-AA
	G1/8	0 ... 16	0 ... 232	20	290	Relative	2 x PNP	54D-P016G-DD0-AA

### Technical data - Output Signal 1 x PNP (optional to be IO-Link configurable)/ 1 x analogue

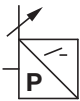
Symbol	Port size	Pressure range (bar)	Pressure range (psi)	Over pressure*1 (bar)	Over pressure*1 (psi)	Type of Pressure	Output Signal	Model
	G1/8	-1 ... 1	-14.5 ... 14.5	20	290	Relative & differential	1 x PNP / 1 x analogue	54D-V101G-DA1-AA
	G1/8	-1 ... 10	-14,5 ... 145	20	290	Relative & differential	1 x PNP / 1 x analogue	54D-V110G-DA1-AA
	G1/8	0 ... 16	0 ... 232	20	290	Relative & differential	1 x PNP / 1 x analogue	54D-P016G-DA1-AA

\*1) Short-term pressure peaks are not allowed to exceed this limit value during operation. Operative utilization of the over pressure is not permitted. The over pressure corresponds to the maximum testing pressure

### Electrical connection M8 x 1 (2 x PNP)

	PIN-No.	Signal	Cable
	1	+ UB	brown
	2	Out 2 (PNP)	white
	3	0 Volt	blue
	4	Out 1 (PNP)	black

### Electrical connection M8 x 1 (1 x PNP, 1 x analogue)

	PIN-No.	Signal	Cable
	1	+ UB	brown
	2	analogue (4...20 mA)	white
	3	0 Volt	blue
	4	Out 1 (PNP)/IO-Link	black

### Option selector

Pressure range (bar)	Substitute
-1 ... 1	V101G
-1 ... 10	V110G
0 ... 16	P016G

54D-\*\*\*\*\*-\*\*\*-AA

Analogue-Type	Substitute
Without IO-Link	0
IO-Link configurable	1
Output Signal	Substitute
2 x PNP	DD
1 x PNP / 1 x Analogue	DA

### Accessories

Connector M8 x 1	DIN-Railclip
	
0523449000000000 (1,5 m Cable,4-pin)	0523446000000000 (1,5 m Cable,4-pin, 90° angled)
0523447000000000 (5 m Cable,4-pin)	54D-DINRAIL-CLIP
	0523448000000000 (5 m Cable,4-pin, 90° angled)

## Dimensions pressure switch

Dimensions in mm  
Projection/First angle

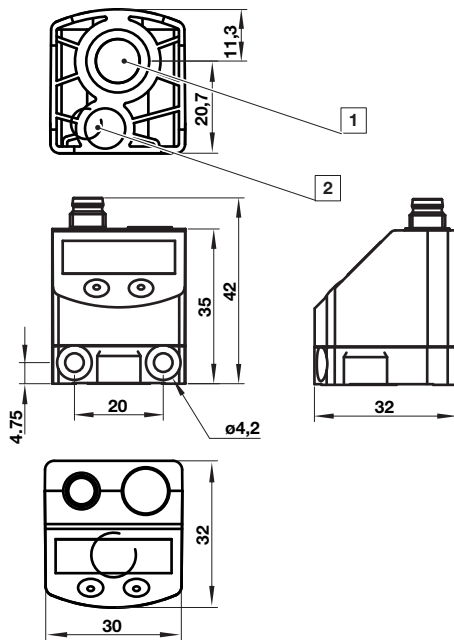

- 1 Main pressure connection (G1/8)
- 2 Auxiliary pressure connection for differential pressure sensing (M5)

## Dimensions accessories DIN-Railclip 54D-DINRAIL-CLIP

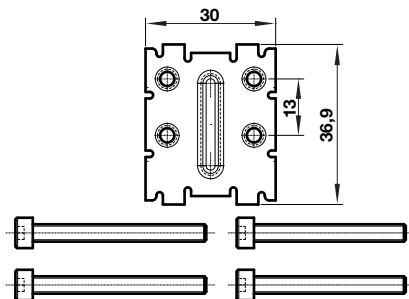

- 1 Mounting screws (Stainless steel, 1.4310/301)
  - 2x M4 x 35
  - 2x M4 x 40

## Warning

These products are intended for use in industrial compressed air and fluid systems only. Do not use these products where pressures and temperatures can exceed those listed under »**Technical features/data**«. Before using these products with fluids other than those specified, for non-industrial applications, life-support systems, or other applications not within published specifications, consult Norgren GmbH.

Through misuse, age, or malfunction, components used in fluid power systems can fail in various modes.

The system designer is warned to consider the failure modes of all component parts used in fluid power systems and to provide adequate safeguards to prevent personal injury or damage to equipment in the event of such failure. System designers must provide a warning to end users in the system instructional manual if protection against a failure mode cannot be adequately provided.

System designers and end users are cautioned to review specific warnings found in instruction sheets packed and shipped with these products.