

VM10 series, 2 x 3/2, 5/2 or 5/3 Valve islands



- > Valve slices 2 x 3/2, 5/2 and 5/3 with integral push-in fittings
ø 3, 4, 6 mm
- > Multipole or individually wired for installation flexibility
- > Interchangeable Fieldbus and Industrial Ethernet modules
- > Fieldbus options available – PROFIBUS DP, DeviceNet and CANopen
- > Industrial Ethernet options available – PROFINET IRT and EtherNet/IP
- > Fieldbus and Industrial Ethernet up to 16 stations (32 solenoids)
- > Compact and lightweight
- > High flow from 10 mm valve width
- > To configure and order a Valve Island visit – www.norgren.com



DeviceNet



EtherNet/IP CANopen

Technical features

Medium:

Compressed air, filtered, lubricated and non-lubricated

Operation:

Spool valve indirectly actuated

Port sizes:

ø 3, 4, 6 mm Push-in fittings
Imperial versions also available

Operating pressure:

-0,9 ... 8 bar depending on pilot supply – see page 2

Flow:

Function	l/min	Cv	Kv
5/2 ports 1 to 2 & 1 to 4	430	0,44	0,36
5/2 ports 2 to 3 & 4 to 5	400	0,41	0,34
3/2 and 5/3	350	0,36	0,29

Insulation protection:

Individually wired: IP40
Multipole, Fieldbus and Industrial Ethernet: IP65

Ambient/Media temperature:

-5 ... +50°C (+23 ... +122°F)
Air supply must be dry enough to avoid ice formation at temperatures below +2°C (+35°F).

Materials:

Body, End plates: Engineered PPA co-polymer
Spool: Aluminium
Seals: NBR

Protection classification

UL/CSA approval

(Industrial Ethernet excluded)



Recognized to UL 429 - 5th edition & CSA 22.2 No.139 – 1982 for Electrically Operated Valves.

Technical data

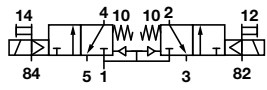
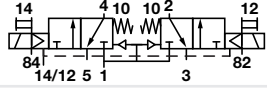
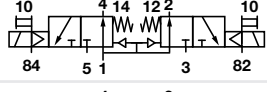
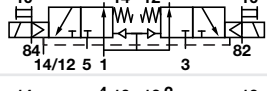
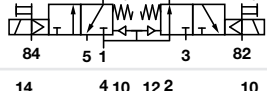
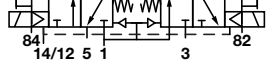
2 x 3/2 Double solenoid actuated valves

Symbol	Function	Actuation	Pilot supply	Manual override	Operating pressure (bar)	Operating pressure (psi)	Pilot pressure (bar)	Pilot pressure (psi)	Weight (kg)	Model
	2x3/2 NC	Solenoid/Spring	Internal	Turn & lock	3 ... 8	43 ... 116	—	—	0,054	VM10*A11AB213B
	2x3/2 NC	Solenoid/Spring	Internal	Push only	3 ... 8	43 ... 116	—	—	0,054	VM10*A11AB313B
	2x3/2 NC	Solenoid/Spring	External	Turn & lock	-0,9 ... 8	-13 ... 116	3 ... 8	43 ... 116	0,054	VM10*A22AB213B
	2x3/2 NC	Solenoid/Spring	External	Push only	-0,9 ... 8	-13 ... 116	3 ... 8	43 ... 116	0,054	VM10*A22AB313B
	2x3/2 NO	Solenoid/Spring	Internal	Turn & lock	3 ... 8	43 ... 116	—	—	0,054	VM10*B11AB213B
	2x3/2 NO	Solenoid/Spring	Internal	Push only	3 ... 8	43 ... 116	—	—	0,054	VM10*B11AB313B
	2x3/2 NO	Solenoid/Spring	External	Turn & lock	-0,9 ... 8	-13 ... 116	3 ... 8	43 ... 116	0,054	VM10*B22AB213B
	2x3/2 NO	Solenoid/Spring	External	Push only	-0,9 ... 8	-13 ... 116	3 ... 8	43 ... 116	0,054	VM10*B22AB313B
	2x3/2 NO/NC	Solenoid/Spring	Internal	Turn & lock	3 ... 8	43 ... 116	—	—	0,054	VM10*C11AB213B
	2x3/2 NO/NC	Solenoid/Spring	Internal	Push only	3 ... 8	43 ... 116	—	—	0,054	VM10*C11AB313B
	2x3/2 NO/NC	Solenoid/Spring	External	Turn & lock	-0,9 ... 8	-13 ... 116	3 ... 8	43 ... 116	0,054	VM10*C22AB213B
	2x3/2 NO/NC	Solenoid/Spring	External	Push only	-0,9 ... 8	-13 ... 116	3 ... 8	43 ... 116	0,054	VM10*C22AB313B

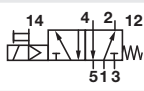
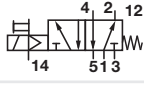
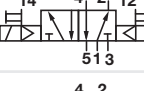
5/2 Single and double solenoid actuated valves

Symbol	Function	Actuation	Pilot supply	Manual override	Operating pressure (bar)	Operating pressure (psi)	Pilot pressure (bar)	Pilot pressure (psi)	Weight (kg)	Model
	5/2	Solenoid/Spring	Internal	Turn & lock	3 ... 8	43 ... 116	—	—	0,044	VM10*517AB213B
	5/2	Solenoid/Spring	Internal	Push only	3 ... 8	43 ... 116	—	—	0,044	VM10*517AB313B
	5/2	Solenoid/Spring	External	Turn & lock	-0,9 ... 8	-13 ... 116	3 ... 8	43 ... 116	0,044	VM10*527AB213B
	5/2	Solenoid/Spring	External	Push only	-0,9 ... 8	-13 ... 116	3 ... 8	43 ... 116	0,044	VM10*527AB313B
	5/2	Solenoid/Solenoid	Internal	Turn & lock	2 ... 8	29 ... 116	—	—	0,054	VM10*511AB213B
	5/2	Solenoid/Solenoid	Internal	Push only	2 ... 8	29 ... 116	—	—	0,054	VM10*511AB313B
	5/2	Solenoid/Solenoid	External	Turn & lock	-0,9 ... 8	-13 ... 116	2 ... 8	29 ... 116	0,054	VM10*522AB213B
	5/2	Solenoid/Solenoid	External	Push only	-0,9 ... 8	-13 ... 116	2 ... 8	29 ... 116	0,054	VM10*522AB313B

5/3 Double solenoid actuated valves

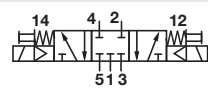
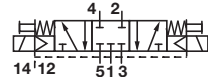
Symbol	Function	Actuation	Pilot supply	Manual override	Operating pressure (bar)	Operating pressure (psi)	Pilot pressure (bar)	Pilot pressure (psi)	Weight (kg)	Model
	5/3 APB	Solenoid/Solenoid	Internal	Turn & lock	3 ... 8	43 ... 116	—	—	0,055	VM10*611AB213B
	5/3 APB	Solenoid/Solenoid	Internal	Push only	3 ... 8	43 ... 116	—	—	0,055	VM10*611AB313B
	5/3 APB	Solenoid/Solenoid	External	Turn & lock	-0,9 ... 8	-13 ... 116	3 ... 8	43 ... 116	0,055	VM10*622AB213B
	5/3 APB	Solenoid/Solenoid	External	Push only	-0,9 ... 8	-13 ... 116	3 ... 8	43 ... 116	0,055	VM10*622AB313B

* For selection of port sizes please see page 3

Note: For 5/3 COE please use 2 x 3/2 NC. For 5/3 COP please use 2 x 3/2 NO

APB = All Ports Blocked COE = Centre Open Exhaust COP = Centre Open Pressure NC = Normally Closed NO = Normally Open

Electrical details

Voltage	24 V d.c. 0,6 W*
Surge suppression	Flywheel diode
Indication	Yellow LED

* 12 V d.c. also available.

Please consult our Technical Service.

Solenoids

Voltage tolerance	± 10%
Rating	100% ED

Option selector - valve slices
VM10★★★★AB★13B

Tube size	Substitute
3 mm PIF	3
4 mm PIF	4
6 mm PIF	6
Valve function	Substitute
5/2	5
5/3 APB	6
2x3/2 NC and 5/3 COE	A
2x3/2 NO and 5/3 COP	B
2x3/2 NC and NO	C

Note:

For 5/3 COE and COP use
 2 x 3/2 APB = All Ports Blocked
 COE = Centre Open Exhaust
 COP = Centre Open Pressure
 NC = Normally Closed
 NO = Normally Open
 For valve island specification see
 page 14 and 15
 *1) Can only be used with 5/2 valve

Manual override	Substitute
Turn to lock	2
Push only	3
Actuation/pilot supply	Substitute
Solenoid/solenoid internal pilot	11
Solenoid/spring internal pilot *1)	17
Solenoid/solenoid external pilot	22
Solenoid/spring external pilot *1)	27

To order a complete valve island
 please use the configurator at;
www.norgren.com

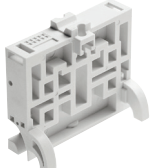
Accessories
Valve blanking station

Page 6

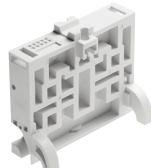
VM106517AQ0300

Pressure zone plate

Page 6

VM106517AQ0301 (Port 1 blanked)

VM106517AQ0302 (Ports 3 & 5 blanked)

VM106517AQ0303 (Ports 1, 3 & 5 blanked)

DIN Rail fixing kit

V11900-C01, 8D

DIN rail

V10009-C00 (1 m)

Label cover kit

V12016-K36 (4 Station)

V12016-K39 (10 Station)

V12016-K37 (6 Station)

V12016-K40 (12 Station)

V12016-K38 (8 Station)

V12016-K41 (16 Station)

Labels

V12033-L02 (write and seal label)

V12034-L02 (paper label)

Pressure switch for pilot ports 12 and 14

Page 16

VM106517AQ0804 (4 mm)

VM106517AQ0806 (6 mm)

Silencer

Page 16

T45P0006 (6 mm)

T45P0008 (8 mm)

T45P0010 (10 mm)

T45P0012 (12 mm)

Plug

Page 16

C00040600 (6 mm)

C00040800 (8 mm)

C00041000 (10 mm)

C00041200 (12 mm)

**Manual override kit
Push only**

V11574-K30

**Rotate by hand,
lockable**

V11574-K31

**D Sub-connector
25 pin, IP65**

Page 14

V11569-E01 (1 m)

V11569-E03 (3 m)

V11569-E05 (5 m)

**D Sub-connector
44 pin, IP65**

Page 14

V11570-E01 (1 m)

V11570-E03 (3 m)

V11570-E05 (5 m)

**D Sub-connector 25 pin
90°, IP65**

Page 15

V12086-E01 (1 m)

V12086-E03 (3 m)

V12086-E05 (5 m)

**D Sub-connector 44 pin
90°, IP65**

Page 15

V12088-E01 (1 m)

V12088-E03 (3 m)







V12088-E05 (5 m)

**2 Pin connector
IP40**

V11556-E10 (1 m)

V11556-E03 (0,3 m)

Fieldbus accessories

	Description	Connection	Cable length	Protection class	Short code*	Model
	Fieldbus power connector DeviceNet (4 pin, female) CANopen (4 pin, female) PROFIBUS DP (4 pin, female)	M12	Wireable	IP65	R1	V11588-E01
	DeviceNet (5 pin, female) CANopen (5 pin, female)	M12	Wireable	IP65	R2	V11589-E01
	PROFIBUS DP, reverse keyway (5 pin, female)	M12	Wireable	IP65	R3	V11590-E01
	PROFIBUS DP, reverse keyway (5 pin male)	M12	Wireable	IP65	R4	V11591-E01
	PROFIBUS DP connector (9 pin, male with terminating resistor)	D-Sub	Wireable	IP40	R0	V11654-E01
	PROFIBUS DP terminating resistor	M12	-	IP65	R6	V11592-E01

* Short code – used in the Online Configurator

Dimensions

Dimensions in mm
Projection/First angle



Single solenoid

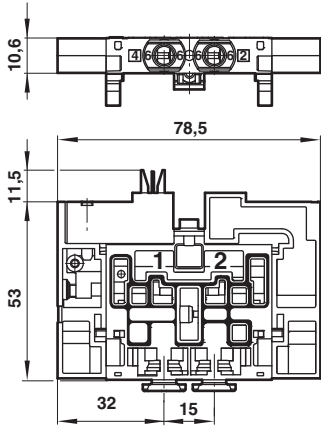

Double solenoid

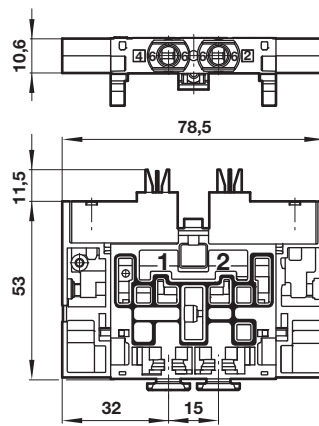

5/3 APB, double solenoid

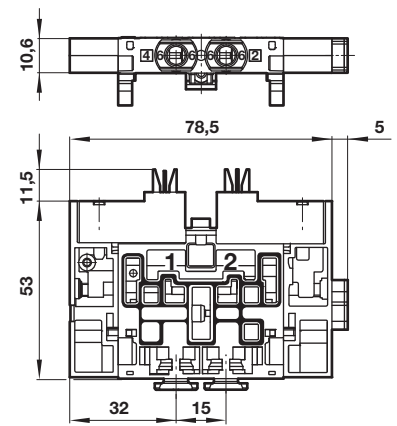

5/2 Single and double solenoid actuated valves

Model	Short code *	Weight (kg)
VM10*517AB213B	NG*T	0,044
VM10*517AB313B	NG*U	0,044
VM10*527AB213B	NH*T	0,044
VM10*527AB313B	NH*U	0,044
VM10*511AB213B	NJ*T	0,054
VM10*511AB313B	NJ*U	0,054
VM10*522AB213B	NK*T	0,054
VM10*522AB313B	NK*U	0,054

2 x 3/2 Double solenoid actuated valves

Model	Short code *	Weight (kg)
VM10*A11AB213B	NA*T	0,054
VM10*A11AB313B	NA*U	0,054
VM10*A22AB213B	ND*T	0,054
VM10*A22AB313B	ND*U	0,054
VM10*B11AB213B	NB*T	0,054
VM10*B11AB313B	NB*U	0,054
VM10*B22AB213B	NE*T	0,054
VM10*B22AB313B	NE*U	0,054
VM10*C11AB213B	NC*T	0,054
VM10*C11AB313B	NC*U	0,054
VM10*C22AB213B	NF*T	0,054
VM10*C22AB313B	NF*U	0,054

5/3 Double solenoid actuated valves

Model	Short code *	Weight (kg)
VM10*611AB213B	NL*T	0,055
VM10*611AB313B	NL*U	0,055
VM107611AB213B	NLZT	0,055
VM107611AB313B	NLZU	0,055
VM10*622AB213B	NM*T	0,055
VM10*622AB313B	NM*U	0,055
VM107622AB213B	NMZT	0,055
VM107622AB313B	NMZU	0,055

Blanking and pressure zone plates

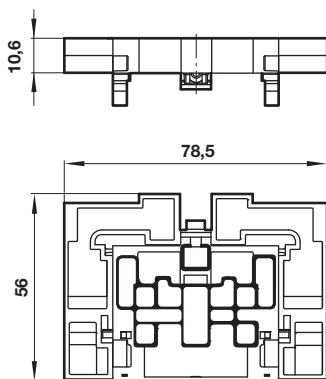

Blanking and pressure zone plates		Short code *	Weight (kg)
VM106517AQ0300	Blanking plate ports open	B000	0,028
VM106517AQ0301	Pressure zone plate (port 1 blanked)	B100	0,028
VM106517AQ0302	Pressure zone plate (ports 3 & 5 blanked)	B300	0,028
VM106517AQ0303	Pressure zone plate (ports 1, 3 & 5 blanked)	B500	0,028

* Short code - used in Online Configurator

Note:

When using a pressure zone plate blanking port 1, it is not possible to use all internal pilot valves on both sides of the zone plate, at least one external pilot valve needs to be used. For further information please contact our technical service.

Valve Island dimensions and port connections

Dimensions in mm
Projection/First angle

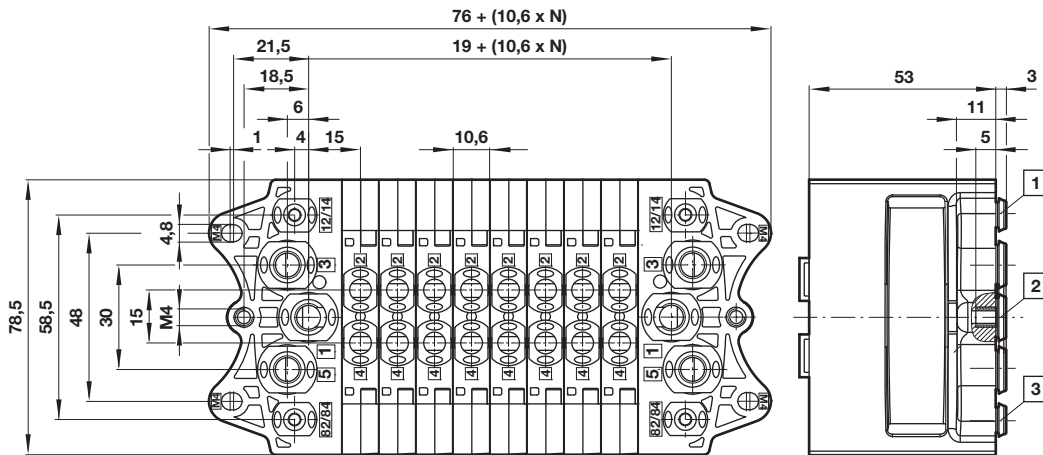

Description	Ports 1, 3 & 5 Tube outside ø	Ports 12/14 & 82/84 Tube outside ø	Ports 2 & 4 Tube outside ø	Short code *1)	Weight (kg)	Model
End plate kit - feed both ends	10	6	6	F100	0,170	VM106517AQ010Y
End plate kit - feed both ends	8	4	4	F800	0,170	VM106517AQ0108
End plate kit - feed left, right blocked	10	6	6	L100	0,170	VM106517AQ011Y
End plate kit - feed left, right blocked	8	4	4	L800	0,170	VM106517AQ0118
End plate kit - feed right, left blocked	10	6	6	R100	0,170	VM106517AQ012Y
End plate kit - feed right, left blocked	8	4	4	R800	0,170	VM106517AQ0128

Available valve port sizes – ø 3 mm, 4 mm and 6 mm

*1) Short code – used in the Online Configurator

Panel cut-out detail

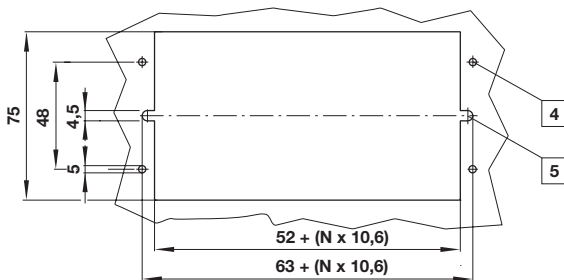

- 4) For mounting island from outside of panel using M4 threads in valve island end plates
- 5) For using through-mounting holes in valve island end plates

Top cover connections - Individually wired and Multipole Individually wired IP40 (no top cover)

Dimensions in mm
Projection/First angle

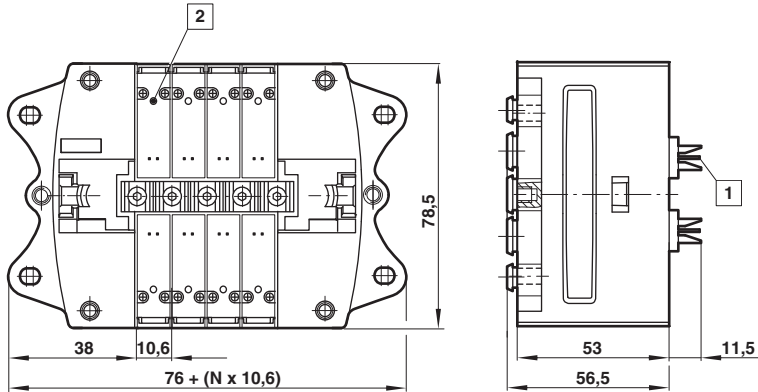

- 1 2 Pin connector
 - 2 Manual override
- N = number of stations

Individually wired	No. of stations	Max. no. of solenoids	Weight (kg)*
2 Pin connector	2 ... 20	40	0,170

* kg + valves weight

Multipole IP65

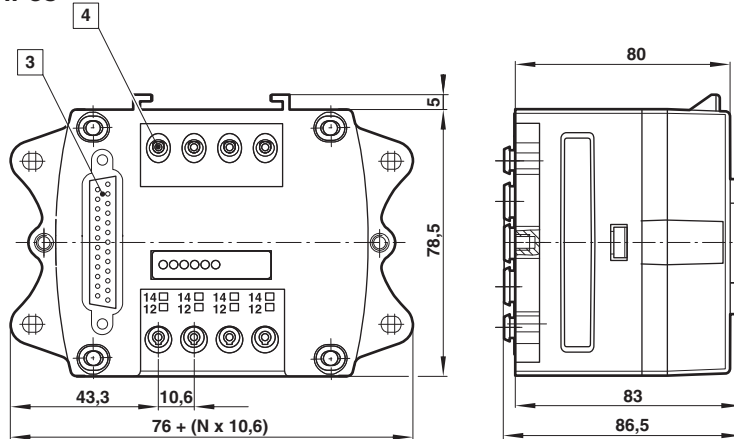

- 3 25 Pin connector for
4, 6, 8, 10 & 12 station
44 Pin connector for 12 & 16 station
 - 4 Manual override, actuate with screw driver
- N = number of stations

Multipole	No. of stations	-ve common Model	Short code *	+ve common Model	Short code *	Max. no. of solenoids	Weight (kg)
25 Pin connector	4	VM106517AQ0404	2N04	VM106517RQ0404	2P04	8	0,116
25 Pin connector	6	VM106517AQ0406	2N06			12	0,122
25 Pin connector	8	VM106517AQ0408	2N08	VM106517RQ0408	2P08	16	0,128
25 Pin connector	10	VM106517AQ0410	2N10			20	0,134
25 Pin connector	12	VM106517AQ0412	2N12	VM106517RQ0412	2P12	24	0,140
44 Pin connector	12	VM106517AQ0512	4N12			24	0,144
44 Pin connector	16	VM106517AQ0516	4N16	VM106517RQ0516	4P16	32	0,160

* Short code – used in the Online Configurator

Top cover connections - Fieldbus and Industrial Ethernet PROFIBUS DP (M12 connector IP65)



Dimensions in mm
Projection/First angle

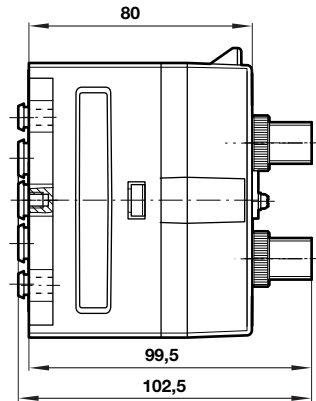
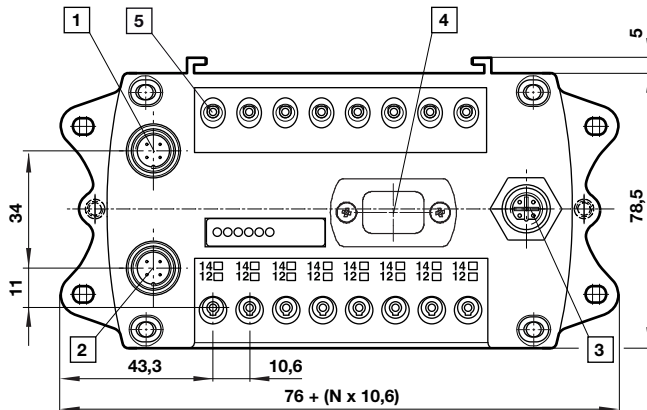

- 1 M12 power connector
- 2 M12 protocol connector (male)
- 3 M12 protocol connector (female)
- 4 Rotary address switch
- 5 Manual override, actuate with screw driver

N = number of stations

Standard fieldbus	No. of stations	Max. no. of solenoids	Short code *	Weight (kg)	Model
PROFIBUS DP	08	16	PS08	0,138	VM10DPFNB00082
PROFIBUS DP	10	20	PS10	0,144	VM10DPFNB00102
PROFIBUS DP	12	24	PS12	0,150	VM10DPFNB00122
PROFIBUS DP	16	32	PS16	0,170	VM10DPFNB00162



* Short code – used in the Online Configurator

Connector details

Power connection: M12 4-pin A-coded

Male	Pin no.	Function	Tolerance	Max. current
	1	24 VB Logic circuit supply	±30%	300 mA
	2	24 VA Valves	±10%	1,5 A
	3	0 V	–	1,53 A
	4	Earth	–	–

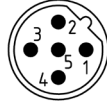
Bus connectors: M12 5-pin B coded

Male Bus in	Female Bus out	Pin no.	Function
		1	5 V I Opto isolator
		2	A-line (green)
		3	0 V I Opto isolated
		4	B-line (red)
		5	Shield

PROFINET IRT (M12 connector IP65)

 Dimensions in mm
 Projection/First angle

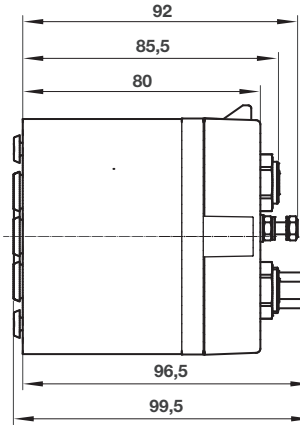
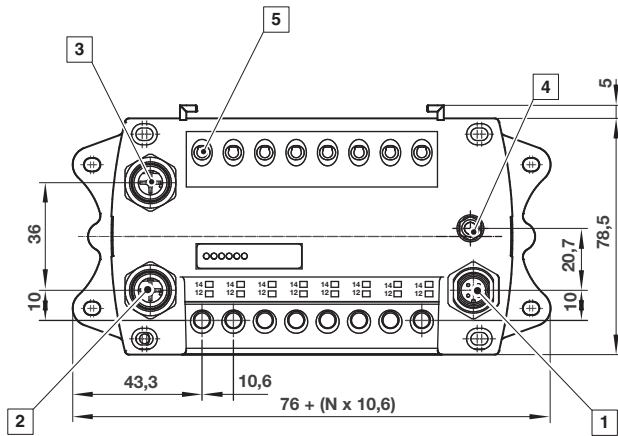
Dimensions for 8 and 10 stations

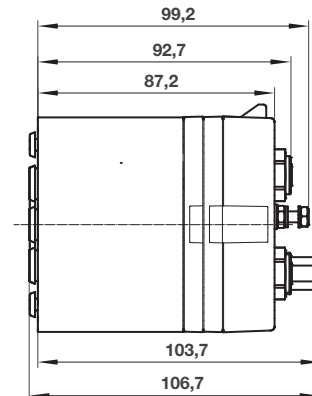
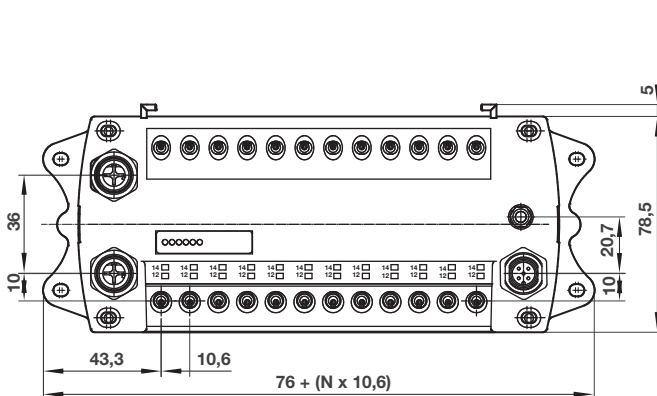

- 1 M12 power connector (male)
 - 2 M12 protocol connector (female)
 - 3 M12 protocol connector (female)
 - 4 Functional earth
 - 5 Manual override, actuate with screw driver
- N = number of stations

Dimensions for 12 and 16 stations

Industrial Ethernet protocol	No. of stations	Max. no. of solenoids	Short code *	Weight (kg)	Model
PROFINET IRT	8	16	PN08	0,3	VM10PNIEB00080
PROFINET IRT	10	20	PN10	0,32	VM10PNIEB00100
PROFINET IRT	12	24	PN12	0,35	VM10PNIEB00120
PROFINET IRT	16	32	PN16	0,37	VM10PNIEB00160

* Short code – used in the Online Configurator

Connector details
Power connector: M12 5-pin A-coded

Male	Pin no.	Function
	1	L1 (VB+) 24V electronics power supply
	2	N2 (VA-) 0V valves power supply
	3	N1 (VB-) 0V electronics power supply
	4	L2 (VA+) 24V valves power supply
	5	FE (functional earth)

Bus connectors: M12 4-pin D-coded

Female	In Pin no.	Function
	1	Transmission Data + (TD+)
	2	Receive Data + (RD+)
	3	Transmission Data - (TD-)
	4	Receive Data - (RD-)
	housing	(FE) functional earth

DeviceNet and CANopen (M12 connector IP65)
DeviceNet
CANopen®

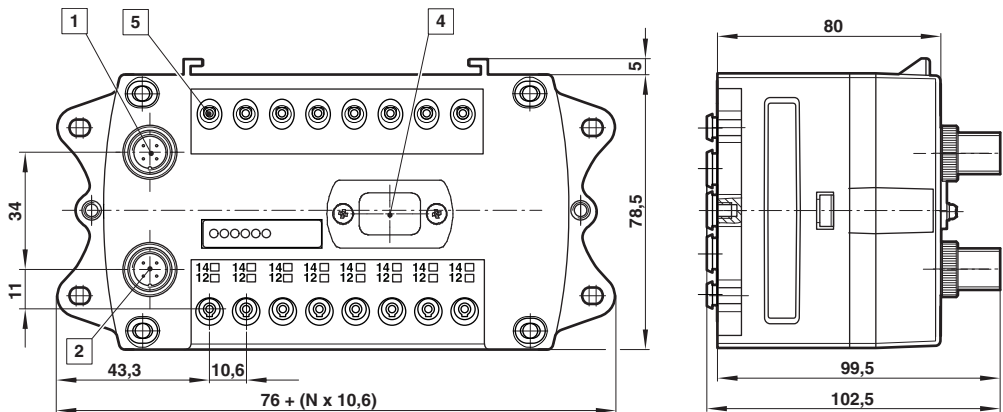
 Dimensions in mm
 Projection/First angle

- 1 M12 power connector
 - 2 M12 protocol connector
 - 4 Rotary address switch
 - 5 Manual override, actuate with screw driver
- N = number of stations

Standard fieldbus	No. of stations	Max. no. of solenoids	Short code *	Weight (kg)	Model
DeviceNet	08	16	DR08	0,138	VM10DNFNB00082
DeviceNet	10	20	DR10	0,144	VM10DNFNB00102
DeviceNet	12	24	DR12	0,150	VM10DNFNB00122
DeviceNet	16	32	DR16	0,170	VM10DNFNB00162
CANopen	08	16	CR08	0,138	VM10CAFNB00082
CANopen	10	20	CR10	0,144	VM10CAFNB00102
CANopen	12	24	CR12	0,150	VM10CAFNB00122
CANopen	16	32	CR16	0,170	VM10CAFNB00162

* Short code – used in the Online Configurator

Connector details
Power connection: M12 4-pin A-coded

Male	Pin no.	Function	Tolerance	Max. current
	1	24 V _B Logic circuit supply	±30%	300 mA
	2	24 V _A Valves	±10%	1,5 A
	3	0 V	-	1,53 A
	4	Earth	-	-

Bus connector: M12 5-pin B-coded

Male	Pin no.	Function
	1	Drain
	2	V+
	3	V-
	4	CAN_H
	5	CAN_L2

EtherNet/IP (M12 connector IP65)
EtherNet/IP™
DeviceNet™

 Dimensions in mm
 Projection/First angle

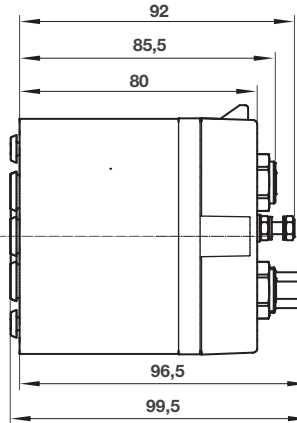
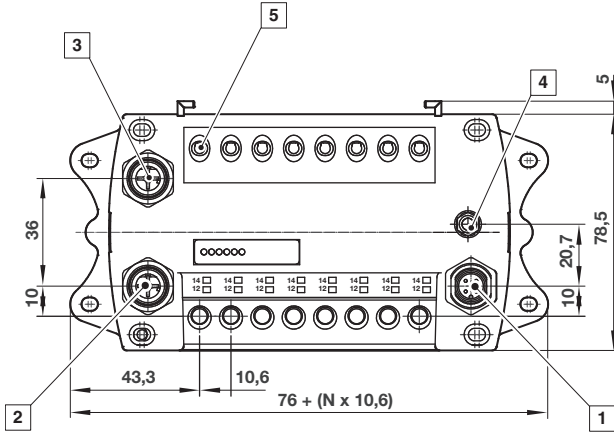
Dimensions for 8 and 10 stations

- 1 M12 power connector (male)
- 2 M12 protocol connector (female)
- 3 M12 protocol connector (female)
- 4 Functional earth
- 5 Manual override, actuate with screw driver

N = number of stations

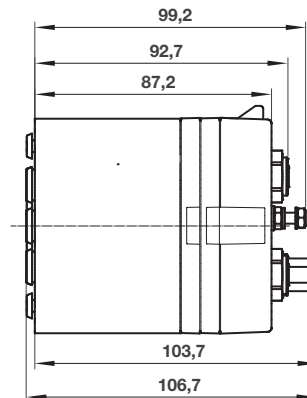
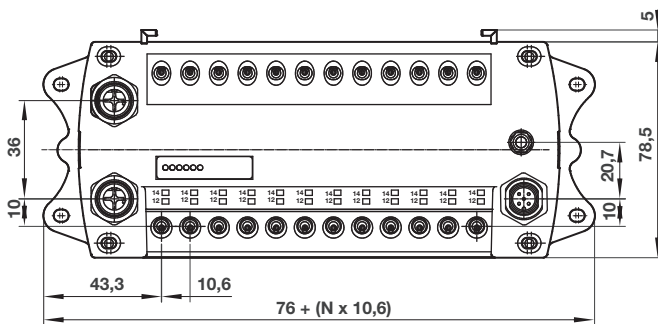
Dimensions for 12 and 16 stations



Industrial Ethernet protocol	No. of stations	Max. no. of solenoids	Short code *	Weight (kg)	Model
EtherNet/IP	8	16	EP08	0,3	VM10EPIEB00080
EtherNet/IP	10	20	EP10	0,32	VM10EPIEB00100
EtherNet/IP	12	24	EP12	0,35	VM10EPIEB00120
EtherNet/IP	16	32	EP16	0,37	VM10EPIEB00160

* Short code – used in the Online Configurator

Connector details
Power connector: M12 5-pin A-coded

Male	Pin no.	Function
	1	L1 (VB+) 24V electronics power supply
	2	N2 (VA-) 0V valves power supply
	3	N1 (VB-) 0V electronics power supply
	4	L2 (VA+) 24V valves power supply
	5	FE (functional earth)

Bus connectors: M12 4-pin D-coded

Female	Pin no.	Function
	1	Transmission Data + (TD+)
	2	Receive Data + (RD+)
	3	Transmission Data - (TD-)
	4	Receive Data - (RD-)
	housing	(FE) functional earth

Multi-pressure options

Single pressure

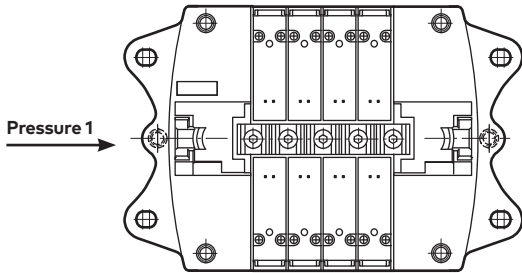

Two pressure

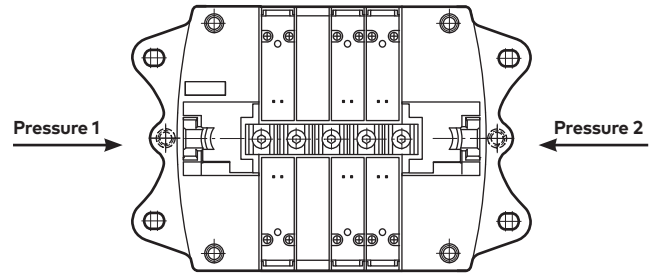

Dimensions in mm
Projection/First angle



Blanking slice
gallery 1
VM106517AQ0301

Three pressure

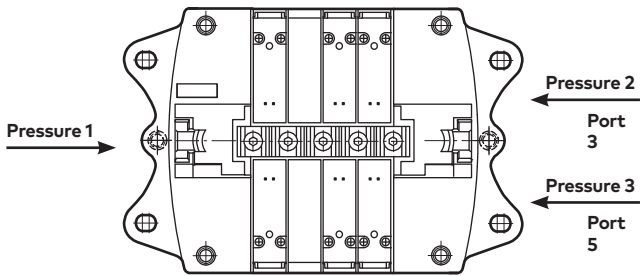

Pressure zone plate
ports 1, 3 & 5 blanked
VM106517AQ0303

Four pressure

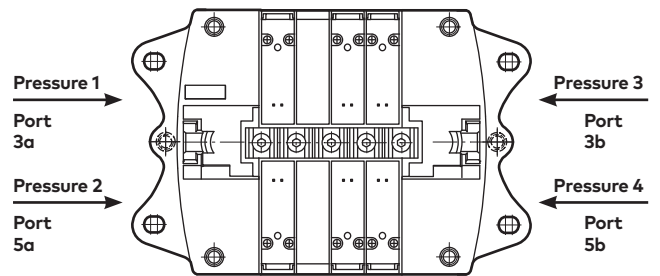

Pressure zone plate
ports 3 & 5 blanked
VM106517AQ0302

Note:

When using a pressure zone plate blanking port 1, it is not possible to use all internal pilot valves on both sides of the zone plate, at least one external pilot valve needs to be used. For further information please contact our technical service.

Three and four pressure zone islands are achieved by using externally piloted 2 x 3/2 valves and reverse porting via ports 3 and 5. By reverse porting the valve's function is also reversed so that a NC becomes NO and NO becomes NC.

D sub-connector 25 pin (IP65)

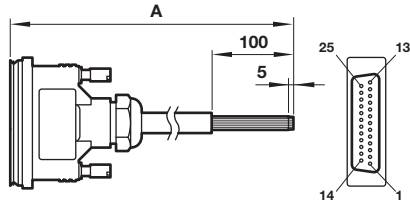

A	Model
1m	V11569-E01
3m	V11569-E03
5m	V11569-E05

Pin no.	Wire colour	Socket	Pilot	Station
1	White	Solenoid 1-a	14	1
2	Brown	Solenoid 2-a	14	2
3	Green	Solenoid 3-a	14	3
4	Yellow	Solenoid 4-a	14	4
5	Grey	Solenoid 5-a	14	5
6	Pink	Solenoid 6-a	14	6
7	Blue	Solenoid 7-a	14	7
8	Red	Solenoid 8-a	14	8
9	Black	Solenoid 9-a	14	9
10	Violet	Solenoid 10-a	14	10
11	Grey/Pink	Solenoid 11-a	14	11
12	Red/Blue	Solenoid 12-a	14	12
13	White/Green	Common-Ve	14	—
14	Brown/Green	Solenoid 1-b	12	1
15	White/Yellow	Solenoid 2-b	12	2
16	Yellow/Brown	Solenoid 3-b	12	3
17	White/Grey	Solenoid 4-b	12	4
18	Grey/Brown	Solenoid 5-b	12	5
19	White/Pink	Solenoid 6-b	12	6
20	Pink/Brown	Solenoid 7-b	12	7
21	White/Blue	Solenoid 8-b	12	8
22	Brown/Blue	Solenoid 9-b	12	9
23	White/Red	Solenoid 10-b	12	10
24	Brown/Red	Solenoid 11-b	12	11
25	White/Black	Solenoid 12-b	12	12

Note: Conforms to IEC60757

D Sub-connector 44 pin (IP65)

Dimensions in mm
Projection/First angle

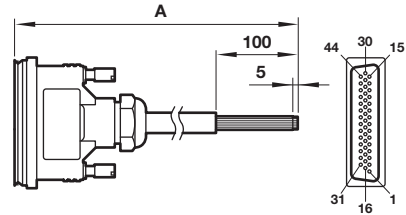

A	Model
1m	V11570-E01
3m	V11570-E03
5m	V11570-E05

Pin no.	Wire colour	Socket	Pilot	Station
1	White	Solenoid 1-a	14	1
2	Brown	Solenoid 2-a	14	2
3	Green	Solenoid 3-a	14	3
4	Yellow	Solenoid 4-a	14	4
5	Grey	Solenoid 5-a	14	5
6	Pink	Solenoid 6-a	14	6
7	Blue	Solenoid 7-a	14	7
8	Red	Solenoid 8-a	14	8
9	Black	Solenoid 9-a	14	9
10	Violet	Solenoid 10-a	14	10
11	Grey/Pink	Solenoid 11-a	14	11
12	Red/Blue	Solenoid 12-a	14	12
13	White/Green	Solenoid 13-a	14	13
14	Brown/Green	Solenoid 14-a	14	14
15	White/Yellow	Solenoid 15-a	14	15
16	Yellow/Brown	Solenoid 1-b	12	1
17	White/Grey	Solenoid 2-b	12	2
18	Grey/Brown	Solenoid 3-b	12	3
19	White/Pink	Solenoid 4-b	12	4
20	Pink/Brown	Solenoid 5-b	12	5
21	White/Blue	Solenoid 6-b	12	6
22	Brown/Blue	Solenoid 7-b	12	7
23	White/Red	Solenoid 8-b	12	8
24	Brown/Red	Solenoid 9-b	12	9
25	White/Black	Solenoid 10-b	12	10
26	Brown/Black	Solenoid 11-b	12	11
27	Grey/Green	Solenoid 12-b	12	12
28	Yellow/Grey	Solenoid 13-b	12	13
29	Pink/Green	Solenoid 14-b	12	14
30	Yellow/Pink	Solenoid 15-b	12	15
31	Green/Blue	Solenoid 16-a	14	16
32	Yellow/Blue	Solenoid 16-b	12	16
33	—	Not used	—	—
34	—	Not used	—	—
35	—	Not used	—	—
36	—	Not used	—	—
37	—	Not used	—	—
38	—	Not used	—	—
39	—	Not used	—	—
40	—	Not used	—	—
41	—	Not used	—	—
42	—	Not used	—	—
43	—	Not used	—	—
44	Red/Black Yellow/Black	Common-Ve	—	—

D Sub-connector 25 pin 90° (IP65)

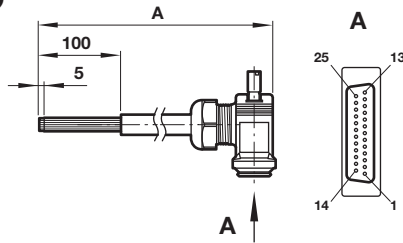

A	Model
1m	V12086-E01
3m	V12086-E03
5m	V12086-E05

D Sub-connector 44 pin 90° (IP65)

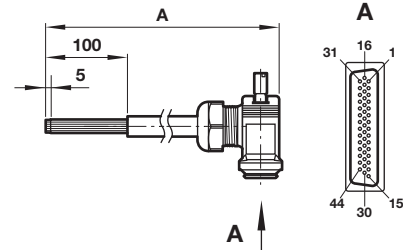

Dimensions in mm
Projection/First angle



A	Model
1m	V12088-E01
3m	V12088-E03
5m	V12088-E05

Pin no.	Wire colour	Socket	Pilot	Station
1	White	Solenoid 1-a	14	1
2	Brown	Solenoid 2-a	14	2
3	Green	Solenoid 3-a	14	3
4	Yellow	Solenoid 4-a	14	4
5	Grey	Solenoid 5-a	14	5
6	Pink	Solenoid 6-a	14	6
7	Blue	Solenoid 7-a	14	7
8	Red	Solenoid 8-a	14	8
9	Black	Solenoid 9-a	14	9
10	Violet	Solenoid 10-a	14	10
11	Grey/Pink	Solenoid 11-a	14	11
12	Red/Blue	Solenoid 12-a	14	12
13	White/Green	Common-Ve		-
14	Brown/Green	Solenoid 1-b	12	1
15	White/Yellow	Solenoid 2-b	12	2
16	Yellow/Brown	Solenoid 3-b	12	3
17	White/Grey	Solenoid 4-b	12	4
18	Grey/Brown	Solenoid 5-b	12	5
19	White/Pink	Solenoid 6-b	12	6
20	Pink/Brown	Solenoid 7-b	12	7
21	White/Blue	Solenoid 8-b	12	8
22	Brown/Blue	Solenoid 9-b	12	9
23	White/Red	Solenoid 10-b	12	10
24	Brown/Red	Solenoid 11-b	12	11
25	White/Black	Solenoid 12-b	12	12

Note: Conforms to IEC60757

Pin no.	Wire colour	Socket	Pilot	Station
1	White	Solenoid 1-a	14	1
2	Brown	Solenoid 2-a	14	2
3	Green	Solenoid 3-a	14	3
4	Yellow	Solenoid 4-a	14	4
5	Grey	Solenoid 5-a	14	5
6	Pink	Solenoid 6-a	14	6
7	Blue	Solenoid 7-a	14	7
8	Red	Solenoid 8-a	14	8
9	Black	Solenoid 9-a	14	9
10	Violet	Solenoid 10-a	14	10
11	Grey/Pink	Solenoid 11-a	14	11
12	Red/Blue	Solenoid 12-a	14	12
13	White/Green	Solenoid 13-a	14	13
14	Brown/Green	Solenoid 14-a	14	14
15	White/Yellow	Solenoid 15-a	14	15
16	Yellow/Brown	Solenoid 1-b	12	1
17	White/Grey	Solenoid 2-b	12	2
18	Grey/Brown	Solenoid 3-b	12	3
19	White/Pink	Solenoid 4-b	12	4
20	Pink/Brown	Solenoid 5-b	12	5
21	White/Blue	Solenoid 6-b	12	6
22	Brown/Blue	Solenoid 7-b	12	7
23	White/Red	Solenoid 8-b	12	8
24	Brown/Red	Solenoid 9-b	12	9
25	White/Black	Solenoid 10-b	12	10
26	Brown/Black	Solenoid 11-b	12	11
27	Grey/Green	Solenoid 12-b	12	12
28	Yellow/Grey	Solenoid 13-b	12	13
29	Pink/Green	Solenoid 14-b	12	14
30	Yellow/Pink	Solenoid 15-b	12	15
31	Green/Blue	Solenoid 16-a	14	16
32	Yellow/Blue	Solenoid 16-b	12	16
33	-	Not used	-	-
34	-	Not used	-	-
35	-	Not used	-	-
36	-	Not used	-	-
37	-	Not used	-	-
38	-	Not used	-	-
39	-	Not used	-	-
40	-	Not used	-	-
41	-	Not used	-	-
42	-	Not used	-	-
43	-	Not used	-	-
44	Red/Black Yellow/Black	Common -Ve	-	-

Pressure switch for pilot ports 12 & 14

Dimensions in mm
Projection/First angle



Voltage	24 V d.c.
Pressure range	0 ... 10 bar
Switching point rising pressure	3 ... 5 bar
Switch point falling pressure	2,5 ... 3,7 bar
AMP E-terminals	2,8 x 0,8
Degree of protection	IP00
Adjustment	None

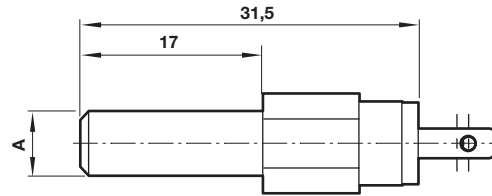

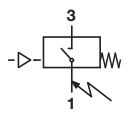
Symbol	A	Short code	Weight (kg)	Model
	4	7A	0,004	VM106517AQ0804
	6	7B	0,004	VM106517AQ0806

Plug C0004

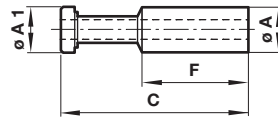

ø A	ø A1	C	F	Model
4	4	30	17,5	C00040400
6	6	34	18,5	C00040600
8	8	38	21	C00040800
10	10	42	24	C00041000

Silencer

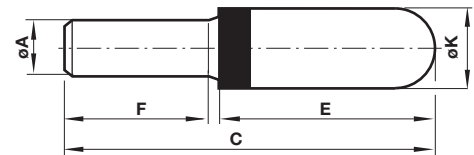
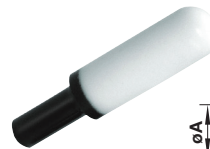

ø A	C	E	F	ø K	Model
4	32	16	14	6,5	T45P0004
6	45	24,5	17	12,5	T45P0006
8	43,5	22	19	13,5	T45P0008
10	57,5	31	23	15,5	T45P0010

Part numbering for complete valve islands

VM10★★★★00-★★★★

Number of stations *1)	Substitute
2 stations	2
3 stations	3
4 stations	4
5 stations	5
6 stations	6
7 stations	7
8 stations	8
9 stations	9
10 stations	10
11 stations	11
12 stations	12
13 stations	13
14 stations	14
15 stations	15
16 stations	16
17 stations	17
18 stations	18
19 stations	19
20 stations	20
Electrical connection	Substitute
Individually Wired	IW
Multipole 25 pin	M2
Multipole 44 pin	M4
PROFIBUS DP	PB
PROFINET IRT	PN
DeviceNet	DN
EtherNet/IP	EP
CANopen	CO

To be defined by online Valve Island configurator based on valve slice selection

*1) Individually wired; 2 to 20 stations
 Multipole; 4, 6, 8, 10, 12 and 16 stations
 Fieldbus and Industrial Ethernet;
 8, 10, 12 and 16 stations

Descriptions and short codes for valve slices used in the Valve Island configurator

Description	Manual override	Short code	Model
2x3/2 - 2x NC - Internal feed valve 3 mm PIF	Turn & lock	NA3T	VM103A11AB213B
2x3/2 - 2x NC - Internal feed valve 3 mm PIF	Push only	NA3U	VM103A11AB313B
2x3/2 - 2x NC - Internal feed valve 4 mm PIF	Turn & lock	NA4T	VM104A11AB213B
2x3/2 - 2x NC - Internal feed valve 4 mm PIF	Push only	NA4U	VM104A11AB313B
2x3/2 - 2x NC - Internal feed valve 6 mm PIF	Turn & lock	NA6T	VM106A11AB213B
2x3/2 - 2x NC - Internal feed valve 6 mm PIF	Push only	NA6U	VM106A11AB313B
2x3/2 - 2x NC - External feed valve 3 mm PIF	Turn & lock	ND3T	VM103A22AB213B
2x3/2 - 2x NC - External feed valve 3 mm PIF	Push only	ND3U	VM103A22AB313B
2x3/2 - 2x NC - External feed valve 4 mm PIF	Turn & lock	ND4T	VM104A22AB213B
2x3/2 - 2x NC - External feed valve 4 mm PIF	Push only	ND4U	VM104A22AB313B
2x3/2 - 2x NC - External feed valve 6 mm PIF	Turn & lock	ND6T	VM106A22AB213B
2x3/2 - 2x NC - External feed valve 6 mm PIF	Push only	ND6U	VM106A22AB313B
2x3/2 - 2x NO - Internal feed valve 3 mm PIF	Turn & lock	NB3T	VM103B11AB213B
2x3/2 - 2x NO - Internal feed valve 3 mm PIF	Push only	NB3U	VM103B11AB313B
2x3/2 - 2x NO - Internal feed valve 4 mm PIF	Turn & lock	NB4T	VM104B11AB213B
2x3/2 - 2x NO - Internal feed valve 4 mm PIF	Push only	NB4U	VM104B11AB313B
2x3/2 - 2x NO - Internal feed valve 6 mm PIF	Turn & lock	NB6T	VM106B11AB213B
2x3/2 - 2x NO - Internal feed valve 6 mm PIF	Push only	NB6U	VM106B11AB313B
2x3/2 - 2x NO - External feed valve 3 mm PIF	Turn & lock	NE3T	VM103B22AB213B
2x3/2 - 2x NO - External feed valve 3 mm PIF	Push only	NE3U	VM103B22AB313B
2x3/2 - 2x NO - External feed valve 4 mm PIF	Turn & lock	NE4T	VM104B22AB213B
2x3/2 - 2x NO - External feed valve 4 mm PIF	Push only	NE4U	VM104B22AB313B
2x3/2 - 2x NO - External feed valve 6 mm PIF	Turn & lock	NE6T	VM106B22AB213B
2x3/2 - 2x NO - External feed valve 6 mm PIF	Push only	NE6U	VM106B22AB313B
2x3/2 - 1x NC + 1x NO - Internal feed valve 3 mm PIF	Turn & lock	NC3T	VM103C11AB213B
2x3/2 - 1x NC + 1x NO - Internal feed valve 3 mm PIF	Push only	NC3U	VM103C11AB313B
2x3/2 - 1x NC + 1x NO - Internal feed valve 4 mm PIF	Turn & lock	NC4T	VM104C11AB213B
2x3/2 - 1x NC + 1x NO - Internal feed valve 4 mm PIF	Push only	NC4U	VM104C11AB313B
2x3/2 - 1x NC + 1x NO - Internal feed valve 6 mm PIF	Turn & lock	NC6T	VM106C11AB213B
2x3/2 - 1x NC + 1x NO - Internal feed valve 6 mm PIF	Push only	NC6U	VM106C11AB313B
2x3/2 - 1x NC + 1x NO - External feed valve 3 mm PIF	Turn & lock	NF3T	VM103C22AB213B
2x3/2 - 1x NC + 1x NO - External feed valve 3 mm PIF	Push only	NF3U	VM103C22AB313B
2x3/2 - 1x NC + 1x NO - External feed valve 4 mm PIF	Turn & lock	NF4T	VM104C22AB213B
2x3/2 - 1x NC + 1x NO - External feed valve 4 mm PIF	Push only	NF4U	VM104C22AB313B
2x3/2 - 1x NC + 1x NO - External feed valve 6 mm PIF	Turn & lock	NF6T	VM106C22AB213B
2x3/2 - 1x NC + 1x NO - External feed valve 6 mm PIF	Push only	NF6U	VM106C22AB313B

Description	Manual override	Short code	Model
5/2 Solenoid/spring - Internal feed valve 3 mm PIF	Turn & lock	NG3T	VM103517AB213B
5/2 Solenoid/spring - Internal feed valve 3 mm PIF	Push only	NG3U	VM103517AB313B
5/2 Solenoid/spring - Internal feed valve 4 mm PIF	Turn & lock	NG4T	VM104517AB213B
5/2 Solenoid/spring - Internal feed valve 4 mm PIF	Push only	NG4U	VM104517AB313B
5/2 Solenoid/spring - Internal feed valve 6 mm PIF	Turn & lock	NG6T	VM106517AB213B
5/2 Solenoid/spring - Internal feed valve 6mm PIF	Push only	NG6U	VM106517AB313B
5/2 Solenoid/spring - External feed valve 3 mm PIF	Turn & lock	NH3T	VM103527AB213B
5/2 Solenoid/spring - External feed valve 3 mm PIF	Push only	NH3U	VM103527AB313B
5/2 Solenoid/spring - External feed valve 4 mm PIF	Turn & lock	NH4T	VM104527AB213B
5/2 Solenoid/spring - External feed valve 4 mm PIF	Push only	NH4U	VM104527AB313B
5/2 Solenoid/spring - External feed valve 6 mm PIF	Turn & lock	NH6T	VM106527AB213B
5/2 Solenoid/spring - External feed valve 6 mm PIF	Push only	NH6U	VM106527AB313B
5/2 Solenoid/solenoid - Internal feed valve 3 mm PIF	Turn & lock	NJ3T	VM103511AB213B
5/2 Solenoid/solenoid - Internal feed valve 3 mm PIF	Push only	NJ3U	VM103511AB313B
5/2 Solenoid/solenoid - Internal feed valve 4 mm PIF	Turn & lock	NJ4T	VM104511AB213B
5/2 Solenoid/solenoid - Internal feed valve 4 mm PIF	Push only	NJ4U	VM104511AB313B
5/2 Solenoid/solenoid - Internal feed valve 6 mm PIF	Turn & lock	NJ6T	VM106511AB213B
5/2 Solenoid/solenoid - Internal feed valve 6 mm PIF	Push only	NJ6U	VM106511AB313B
5/2 Solenoid/solenoid - External feed valve 3 mm PIF	Turn & lock	NK3T	VM103522AB213B
5/2 Solenoid/solenoid - External feed valve 3 mm PIF	Push only	NK3U	VM103522AB313B
5/2 Solenoid/solenoid - External feed valve 4 mm PIF	Turn & lock	NK4T	VM104522AB213B
5/2 Solenoid/solenoid - External feed valve 4 mm PIF	Push only	NK4U	VM104522AB313B
5/2 Solenoid/solenoid - External feed valve 6 mm PIF	Turn & lock	NK6T	VM106522AB213B
5/2 Solenoid/solenoid - External feed valve 6 mm PIF	Push only	NK6U	VM106522AB313B
5/3 APB Solenoid/solenoid - Internal feed valve 3 mm PIF	Turn & lock	NL3T	VM103611AB213B
5/3 APB Solenoid/solenoid - Internal feed valve 3 mm PIF	Push only	NL3U	VM103611AB313B
5/3 APB Solenoid/solenoid - Internal feed valve 4 mm PIF	Turn & lock	NL4T	VM104611AB213B
5/3 APB Solenoid/solenoid - Internal feed valve 4 mm PIF	Push only	NL4U	VM104611AB313B
5/3 APB Solenoid/solenoid - Internal feed valve 6 mm PIF	Turn & lock	NL6T	VM106611AB213B
5/3 APB Solenoid/solenoid - Internal feed valve 6 mm PIF	Push only	NL6U	VM106611AB313B
5/3 APB Solenoid/solenoid - External feed valve 3 mm PIF	Turn & lock	NM3T	VM103622AB213B
5/3 APB Solenoid/solenoid - External feed valve 3 mm PIF	Push only	NM3U	VM103622AB313B
5/3 APB Solenoid/solenoid - External feed valve 4 mm PIF	Turn & lock	NM4T	VM104622AB213B
5/3 APB Solenoid/solenoid - External feed valve 4 mm PIF	Push only	NM4U	VM104622AB313B
5/3 APB Solenoid/solenoid - External feed valve 6 mm PIF	Turn & lock	NM6T	VM106622AB213B
5/3 APB Solenoid/solenoid - External feed valve 6 mm PIF	Push only	NM6U	VM106622AB313B

Descriptions and short codes for end plates used in the Valve Island configurator

Description	Manual override	Short code	Model
End plate kit - feed both ends	10 mm	F100	VM106517AQ010Y
End plate kit - feed both ends	8 mm	F800	VM106517AQ0108
End plate kit - feed left, right blocked	10 mm	L100	VM106517AQ011Y
End plate kit - feed left, right blocked	8 mm	L800	VM106517AQ0118
End plate kit - feed right, left blocked	10 mm	R100	VM106517AQ012Y
End plate kit - feed right, left blocked	8 mm	R800	VM106517AQ0128

Warning

These products are intended for use in industrial compressed air systems only. Do not use these products where pressures and temperatures can exceed those listed under »Technical features/data«. Before using these products with fluids other than those specified, for non-industrial applications, life-support systems or other applications not within published specifications, consult Norgren. Through misuse, age, or malfunction, components used in fluid power systems can fail in various modes.

Please be aware that any unauthorised interference/tampering of the product and/or use contrary to any of the manufacturer's instructions may invalidate the product warranty.

The system designer is warned to consider the failure modes of all component parts used in fluid power systems and to provide adequate safeguards to prevent personal injury or damage to equipment in the event of such failure.

System designers must provide a warning to end users in the system instructional manual if protection against a failure mode cannot be adequately provided.

System designers and end users are cautioned to review specific warnings found in instruction sheets packed and shipped with these products.