

RA/192000/M, ISO Compact cylinder

Magnetic piston, double acting

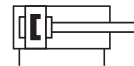

- > \varnothing 20 ... 125 mm
- > Conforms to ISO 21287
- > M/50 switches can be mounted flush with the profile
- > Magnetic piston as standard
- > Seals ensure low friction operation and long life
- > Three different guiding systems: RA/192000/N2, .../N4 or .../N6

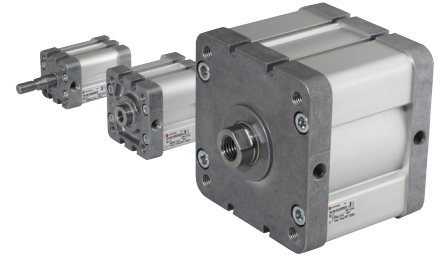

Technical features

Medium:

Compressed air, filtered, lubricated or non-lubricated

Standard:

Based on ISO 21287

Operation:

RA/192000/M: Double acting, magnetic piston, male piston rod thread, buffer cushioning
RA/192000/MX: Double acting, magnetic piston, female piston rod thread, buffer cushioning

Operating pressure:

1 ... 10 bar (14 ... 145 psi)

Ports:

M5, G1/8 ... G1/4

Cylinder diameters:

20, 25, 32, 40, 50, 63, 80, 100 and 125 mm

Standard Strokes:

See table below (standard stroke lengths)

Non-standard strokes:

\varnothing 20 ... 25 mm (5 ... 200 mm)
 \varnothing 32 ... 40 mm (5 ... 300 mm)
 \varnothing 50 ... 63 mm (10 ... 400 mm)
 \varnothing 80 ... 125 mm (15 ... 500 mm)

Operating temperature:

-5 ... +80 °C max. (+23 ... +176 °F)
Air supply must be dry enough to avoid ice formation at temperatures below +2 °C (+35 °F).

Materials:

Profile barrel: Anodized aluminium
End covers: Pressure diecast aluminium
Piston rod: Stainless steel
Piston rod seals: PUR
Piston seals: NBR
O-rings: NBR

Technical data

Cylinder \varnothing (mm)	20	25	32	40	50	63	80	100	125
Port size	M 5	M 5	G 1/8	G 1/8	G 1/8	G 1/8	G 1/8	G 1/8	G 1/4
Piston rod \varnothing (mm)	10	10	12	16	20	20	25	25	32
Piston rod thread	M8x1,25	M8x1,25	M10x1,25	M10x1,25	M12x1,25	M12x1,25	M16x1,5	M16x1,5	M27x2
Energy (J) max.	0,2	0,3	0,45	0,75	1,1	1,3	1,9	2,3	3
Theoretical thrusts at 6 bar outstroke (N)	188	294	482	754	1178	1870	3016	4710	7363
Theoretical thrusts at 6 bar instroke (N)	141	247	414	633	990	1680	2722	4416	6882
Air consumption at 6 bar outstroke (l/cm)	0,022	0,035	0,056	0,088	0,137	0,218	0,35	0,55	0,86
Air consumption at 6 bar instroke (l/cm)	0,016	0,028	0,048	0,074	0,114	0,195	0,32	0,51	0,79

Technical data, Tandem Cylinder (increased force), RA/1920xx/TM.

For Model only RA/1920xx/TM..	20	25	32	40	50	63	80	100
Energy (J) max.	0,2	0,3	0,45	0,75	1,1	1,3	1,9	2,3
Theoretical thrusts at 6 bar outstroke (N)	330	542	897	1387	2168	3552	5737	9130
Theoretical thrusts at 6 bar instroke (N)	141	247	414	633	990	1680	2722	4416
Air consumption at 6 bar outstroke (l/cm)	0,038	0,063	0,105	0,162	0,253	0,414	0,669	1,065
Air consumption at 6 bar instroke (l/cm)	0,016	0,028	0,048	0,074	0,114	0,195	0,32	0,51

Standard strokes

Cylinder \varnothing (mm)	Stroke length (mm)										
	5	10	15	20	25	30	40	50	60	80	100
20	•	•	•	•	•	•	•	•	–	–	–
25	•	•	•	•	•	•	•	•	–	–	–
32	•	•	•	•	•	•	•	•	–	–	–
40	•	•	•	•	•	•	•	•	–	–	–
50	–	•	•	•	•	•	•	•	•	•	•
63	–	–	•	•	•	•	•	•	•	•	•
80	–	–	•	•	•	•	•	•	•	•	•
100	–	–	•	•	•	•	•	•	•	•	•
125	–	–	•	•	•	•	•	•	•	•	•

Design and sizing in pneumatics

Golden Rules

Design and sizing in pneumatics is often based upon experience coupled with an element of fear of under specifying crucial equipment. In an attempt to ensure enough power, engineers may select over sized cylinders and then select over sized valves to supply them with enough air. The same uncertainty can also lead to over sized specification of air line equipment, fittings and tubing. The outcome is components larger than necessary that use too much compressed air and waste energy and money. However when following some well proven golden rules and a few laws of pneumatics it is easy to achieve correctly sized pneumatic installations.

Basics to Consider





The force required, the pressure available, the speed of movement and air consumption. ISO and VDMA standard or compact style also cushioning and sensors. Cylinders are greased on assembly and operate under normal conditions without additional lubrication. However using a lubricator will extend the life of these products.

Golden Rule:

The theoretical force of the cylinder should be 25% extra for high speed, 50% extra for low speed and 100% extra for ultra low speed (positioning) applications.

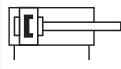

The correct sizing is based upon the required force and applied pressure. Go to page 1 for more information on cylinder sizing and air consumption.

Additional ISO 15552 Cylinder ranges (Cylinder ranges in the red frame are shown in this data sheet)

													
Symbols		Profile barrel	Round Barrel	Industrial Automation	Food & Beverage	Automotive	ATEX II 2GD	Rail *1)	CE-marked	ø (mm)	Range	Description	Datasheet
 		•	•	•	•					20 ... 125	RA/192000	Double Acting Cylinder	de_1_5_084_RA_192000_M
							•		•	20 ... 125	RA/192000/M/EX		de_1_5_085_RA_192000_M_EX
 		•	•	•	•					20 ... 63	RA/191000, RA/193000	Single Acting Cylinder	de_1_4_084_RA_191000_M

• Range available. For additional information please contact the technical service or <http://www.norgren.com> *1) Rail Cylinder Shock and vibration tested to EN 61373 Category 1; Class A + B

Cylinder variants

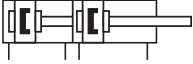
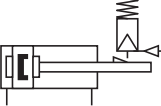
Symbol	Versions	Piston Rod Material	Standard Model with	ø	Description	Page	
See the description below	T	R	S	Male Piston Rod Thread	Female Piston Rod Thread	(mm)	
	•	X	• RA/192000/M	RA/192000/MX	20 ... 125	Standard Cylinder *1)	7
		X	• RA/192000/W2	RA/192000/W2X	20 ... 25	Cylinder with Special Wiper - Seal	
		X	• RA/192000/X4	RA/192000/X4X	32 ... 100	Low Friction Cylinder Operating pressure: 1 ... 10 bar, Medium: Compressed air, filtered and non-lubricated recommended	
		X	• RA/192000/MU	RA/192000/MUX	20 ... 125	Cylinder with Extended Piston Rod ø 20 ... 25 mm (Stroke + Extension = 300 mm) ø 32 ... 40 mm (Stroke + Extension = 400 mm) ø 50 ... 63 mm (Stroke + Extension = 500 mm) ø 80 ... 125 mm (Stroke + Extension = 600 mm)	
	•	X	• RA/192000/JM	RA/192000/JMX	20 ... 125	Cylinder with Double Ended Piston Rod *1)	
		X	RA/192000/N2	RA/192000/N2X	20 ... 100	Cylinder with Non-Rotating Piston Rod	
		X	RA/192000/N4		20 ... 100	Cylinder with guiding ø 20 ... 25 mm (max. Stroke = 80 mm) ø 32 ... 100 mm (max. Stroke = 100 mm)	
		X	RA/192000/N6		25 ... 32	Cylinder with External Guiding Standard Strokes 25, 50, 75 and 100 mm only	
		X	• RA/192000/TM	RA/192000/TMX	20 ... 100	Tandem Cylinder (increased force)	
		X	• RA/192000/SM	RA/192000/SMX	20 ... 100	Multi Position Cylinder	
		X	• RA/192000/L4	RA/192000/L4X	32 ... 125	Cylinder with Locking unit (Passive) Spring force on removal of the signal to the unit. Operating pressure for locking unit: 4 ... 10 bar	

Alternative Variants without Magnet piston (ø 63 ... 125 mm) on request.

*1) Varinate T: ø 20 ... 100 mm; max. Stroke 200 mm

T = High temperature +150 °C (+302 °F); Piston Rod Material: R = Stainless steel martensitic; S = Stainless steel austenitic; X = Standard; • = Option

Option selector

Special variants	Substitute
High temperature version: 150 °C max.	T
Piston rod materials	Substitute
Stainless steel martensitic (1.4021)	R
Stainless steel austenitic (1.4305)	S
Cylinder ø (mm)	Substitute
20	020
25	025
32	032
40	040
50	050
63	063
80	080
100	100
125	125

Note: If option is not required, disregard option position within part number eg. RA/192100/M/100. For combinations of cylinder variants consult our technical service.

Please note that heat resistant seals are not available for all variants.

This options selector explains only the cylinder variants.







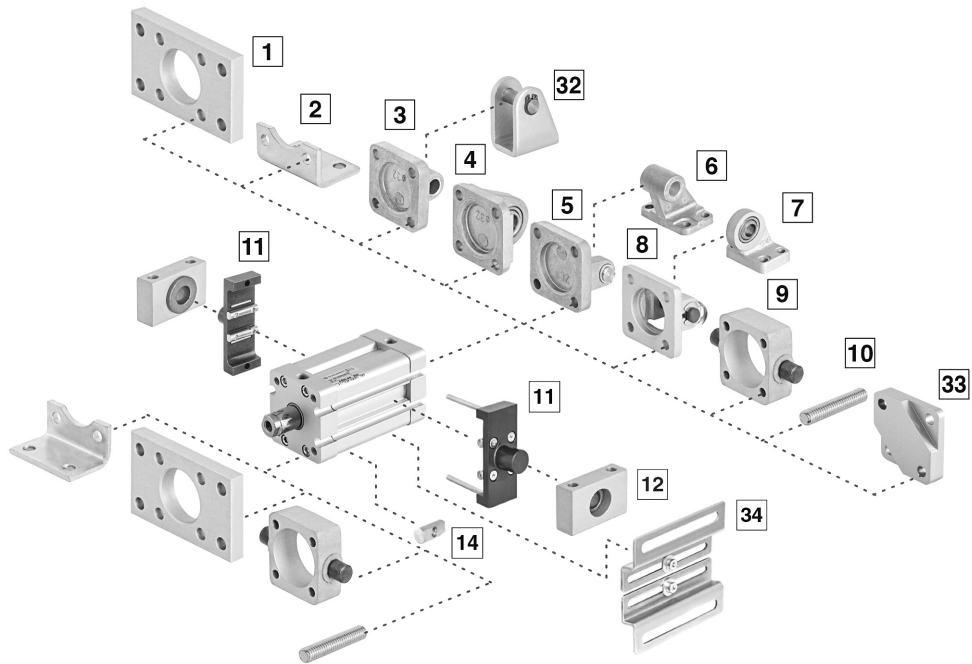
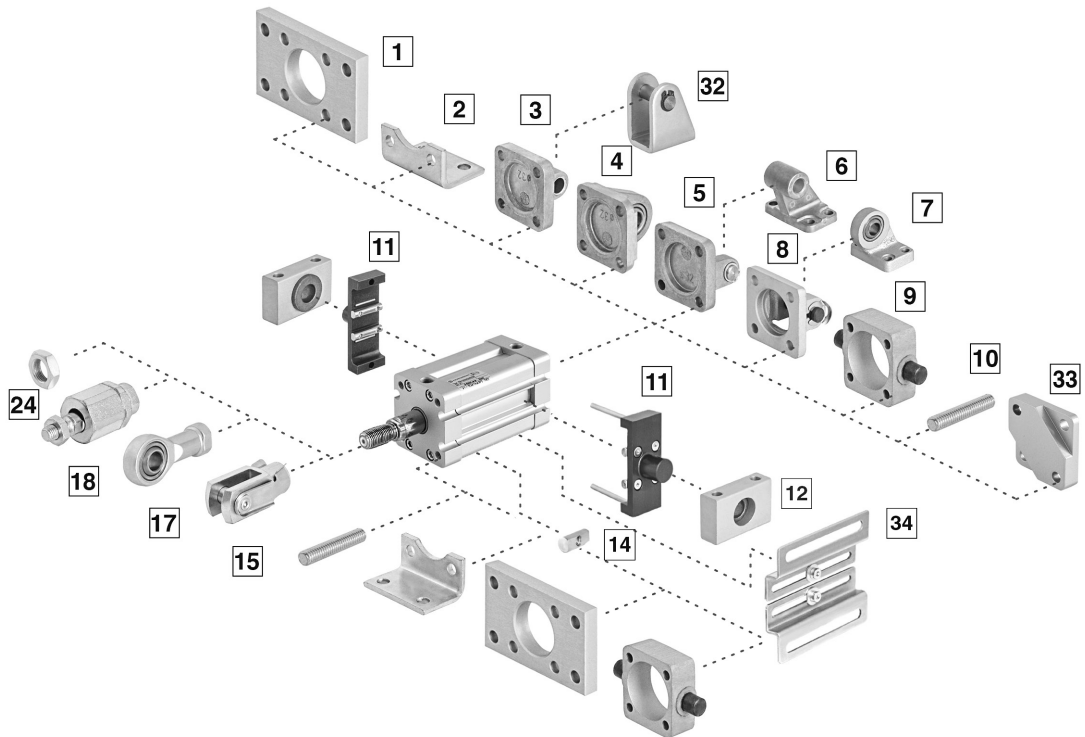







Additional variants/options can not be derived from.

★★A/192★★/★★/★★

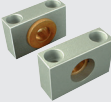
Strokes (mm)	Substitute
ø 20 and 25	5 < 200
ø 32 and 40	5 < 300
ø 50 and 63	10 < 400
ø 80 to 125	15 < 500
Piston rod thread	Substitute
Female	X
Male	None
Variants (magnetic piston)	Substitute
Standard	M
Double ended piston rod	JM
Non-rotating piston rod (internal)	N2
Guiding	N4
Special wiper/seal	W2
Locking unit	L4
External guiding	N6
Extended piston rod	MU
RA/192***/MU*/***/**	
	→ Extension (mm)
Low friction	X4
Tandem cylinder	TM
Multi-positon cylinder	SM
RA/192***/SM*/***/**	
	→ Rear cylinder stroke
	→ Front cylinder stroke







Series RA/192000/MX

Series RA/192000/M

Mountings

Model	A	B, G	C	D	D2	FH	L2
							
	10	1	2	5	8	9	32
ø	Page 11	Page 11	Page 11	Page 12	Page 12	Page 12	Page 13
20	—	QA/192020/22	QM/192020/21	—	—	—	QM/8020/44
25	—	QA/192025/22	QM/192025/21	—	—	—	QM/8020/44
32	QM/8032/35	QA/8032/22	QA/192032/21	QA/8032/23	QA/8032/42	QA/8032/34	—
40	QM/8032/35	QA/8040/22	QA/192040/21	QA/8040/23	QA/8040/42	QA/8040/34	—
50	QM/8050/35	QA/8050/22	QA/192050/21	QA/8050/23	QA/8050/42	QA/8050/34	—
63	QM/8050/35	QA/8063/22	QA/192063/21	QA/8063/23	QA/8063/42	QA/8063/34	—
80	QM/8080/35	QA/8080/22	QA/192080/21	QA/8080/23	QA/8080/42	QA/8080/34	—
100	QM/8080/35	QA/8100/22	QA/192100/21	QA/8100/23	QA/8100/42	QA/8100/34	—
125	QM/8125/35	QM/8125/22	QM/8125/21	QM/8125/23	QA/8125/42	QA/8125/34	—
Model	R	S	SW	UH	UR	US	Assembly Kit
							
	3	12	6	11	4	7	33
ø	Page 12	Page 13	Page 14	Page 13	Page 13	Page 14	Page 15
20	QM/192020/27	—	—	—	—	—	QA/192020/55
25	QM/192025/27	—	—	—	—	—	QA/192025/55
32	QA/8032/27	QA/8032/41	M/P19493	PQA/182032/40	QA/8032/33	M/P40310	QA/192032/55
40	QA/8040/27	QA/8040/41	M/P19494	PQA/182040/40	QA/8040/33	M/P40311	QA/192040/55
50	QA/8050/27	QA/8040/41	M/P19495	PQA/182050/40	QA/8050/33	M/P40312	QA/192050/55
63	QA/8063/27	QA/8063/41	M/P19496	PQA/182063/40	QA/8063/33	M/P40313	QA/192063/55
80	QA/8080/27	QA/8063/41	M/P19497	PQA/182080/40	QA/8080/33	M/P40314	QA/192080/55
100	QA/8100/27	QA/8100/41	M/P19498	PQA/182100/40	QA/8100/33	M/P40315	QA/192100/55
125	QM/8125/27	QA/8100/41	M/P19499	PQA/182125/40	QM/8125/33	M/P71355	QA/192125/55

For cylinders with male piston rod thread

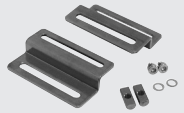
Accessories

Model	AK	F	N2	UF	Groove cover	Magnetically operated switches	Groove key	Valve mounting kit
								
	18	15	24	17			14	34
ø	Page 11	Page 12	Page 13	Page 12	Page 15	Page 16 & 17	Page 15	Page 15
20	QM/8020/38	QM/8020/25	M/P1501/60	QM/8020/32	M/P72725/1000		M/P72816	—
25	QM/8020/38	QM/8020/25	M/P1501/60	QM/8020/32	M/P72725/1000		M/P72816	—
32	QM/8025/38	QM/8025/25	M/P1501/89	QM/8025/32	M/P72725/1000		M/P72816	—
40	QM/8025/38	QM/8025/25	M/P1501/89	QM/8025/32	M/P72725/1000		M/P72816	—
50	QM/8040/38	QM/8040/25	M/P1501/90	QM/8040/32	M/P72725/1000		M/P72816	QA/180050/22/54
63	QM/8040/38	QM/8040/25	M/P1501/90	QM/8040/32	M/P72725/1000		M/P72816	QA/180050/22/54
80	QM/8050/38	QM/8050/25	M/P1501/91	QM/8050/32	M/P72725/1000		M/P72816	QA/180080/22/54
100	QM/8050/38	QM/8050/25	M/P1501/91	QM/8050/32	M/P72725/1000		M/P72816	QA/180080/22/54
125	QM/8125/38	QM/8125/25	M/P1501/105	QM/8125/32	M/P72725/1000		M/P72816	QA/180080/22/54

Pos.	Style	Standard	Pos.	Style	Standard	Pos.	Style	Standard
1	B, G	Clear anodised aluminium	7	US	Coatet cast iron Inner ring: steel, Outer ring: brass	15	F	Galvanized steel, Bolt: galvanized steel, Circlip: Galvanized steel
2	C	Coated steel (ø 20 ... 125 mm)	8	D2	Die-cast aluminium (ø 32 ... 125 mm) Bolt: stainless steel (martensitic), Circlip: galvanized steel	17	UF	Galvanized steel, Inner ring: steel, Outer ring: brass
3	R	Die-cast aluminium (ø 20 ... 100 mm) Coated cast iron (ø 125 mm)	9	FH	Coated cast iron	18	AK	Galvanized steel
4	UR	Die-cast aluminium (ø 32 ... 100 mm) Coated cast iron (ø 125 mm) Inner ring: steel, Outer ring: brass	10	A	Galvanized steel	24	N2	Galvanized steel
5	D	Die-cast aluminium (ø 32 ... 125 mm) Bolt: galvanized steel (martensitic) Circlip: galvanized steel	11	UH	Anodised aluminium	32	L2	Galvanized steel
6	SW	Die-cast aluminium (ø 32 ... 100 mm) Coated cast iron (ø 125 mm)	12	S	Clear anodised aluminium Bearing: brass	33		Anodised aluminium
			14	Groove key	Steel	34	Valve mounting kit	Galvanized steel

Spares kit for profile barrel

(wearing parts to be replaced are: piston seals, barrel seals, damping seals and piston rod seals as well as the wear ring)



Spares kit		Option					
Piston rod thread	Male thread		M / MU / JM / L4 / N4 / N6	W2	N2	X4	TM / SM
	Female thread		MX / MUX / JMX / L4X	W2X	N2X	X4X	TMX / SMX
Standard	Model	ø	Standard temperature (-5 °C ... +80 °C)				
	RA/192*** SA/192***	020	QM/192020/00	QM/192020/W2/00	QM/192020/N2/00	-	2x QM/192020/00
		025	QM/192025/00	QM/192025/W2/00	QM/192025/N2/00	-	2x QM/192025/00
		032	QM/192032/00	-	QM/192032/N2/00	QM/192032/X4/00	2x QM/192032/00
		040	QM/192040/00	-	QM/192040/N2/00	QM/192040/X4/00	2x QM/192040/00
		050	QM/192050/00	-	QM/192050/N2/00	QM/192050/X4/00	2x QM/192050/00
		063	QM/192063/00	-	QM/192063/N2/00	QM/192063/X4/00	2x QM/192063/00
		080	QM/192080/00	-	QM/192080/N2/00	QM/192080/X4/00	2x QM/192080/00
		100	QM/192100/00	-	QM/192100/N2/00	QM/192100/X4/00	2x QM/192100/00
		125	QM/192125/00	-	-	-	2x QM/192125/00
Special option		Model	ø	High temperature (0 °C ... +150 °C)			
	TRA/192*** TSA/192***	020	TQM/192020/00	-	-	-	-
		025	TQM/192025/00	-	-	-	-
		032	TQM/192032/00	-	-	-	-
		040	TQM/192040/00	-	-	-	-
		050	TQM/192050/00	-	-	-	-
		063	TQM/192063/00	-	-	-	-
		080	TQM/192080/00	-	-	-	-
		100	TQM/192100/00	-	-	-	-
		125	-	-	-	-	-

*** = Stroke

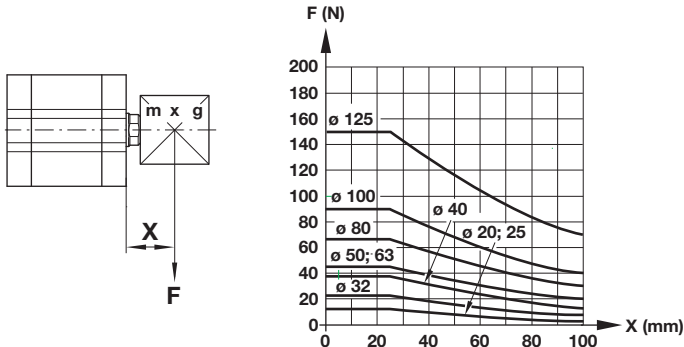
RA/192000/M. – Standard cylinder
RA/192000/N2. – Cylinder with non-rotating piston rod
Side load

ø	Torque max. (Nm)	Model
20	0,15	RA/192020/M. RA/192020/N2.
25	0,25	RA/192025/M. RA/192025/N2.
32	0,4	RA/192032/M. RA/192032/N2.
40	0,75	RA/192040/M. RA/192040/N2.
50	1,5	RA/192050/M. RA/192050/N2.
63	1,5	RA/192063/M. RA/192063/N2.
80	2,5	RA/192080/M. RA/192080/N2.
100	2,5	RA/192100/M. RA/192100/N2.

Special variant: TRA/192000
F x 0,5

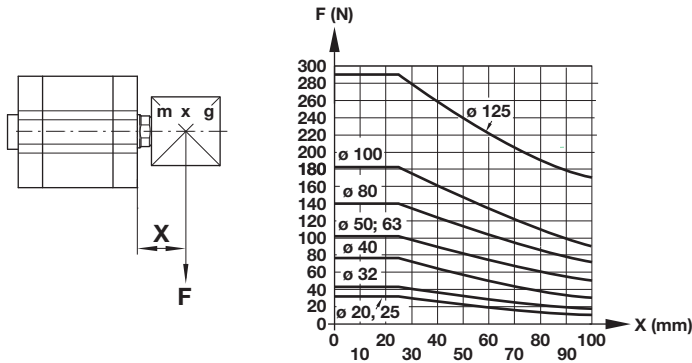
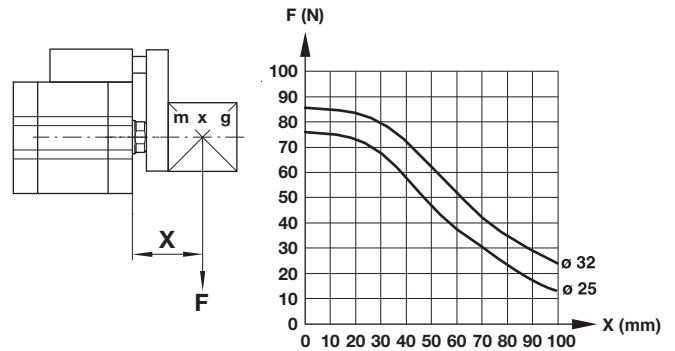
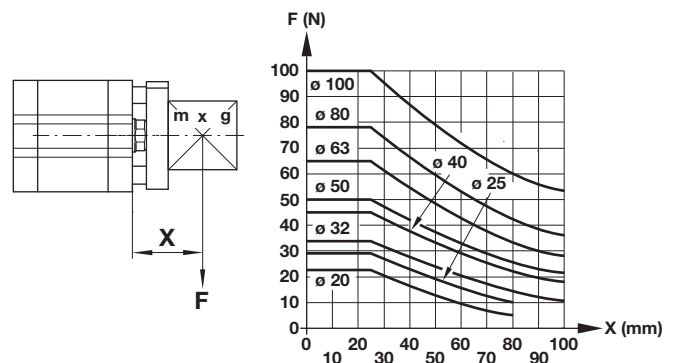
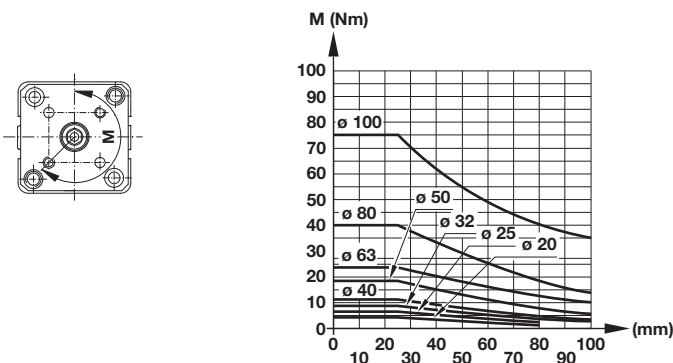
RA/192000/JM – Cylinder with double ended
piston rod
Side load

RA/192000/N6 – Cylinder with external guiding
Side load

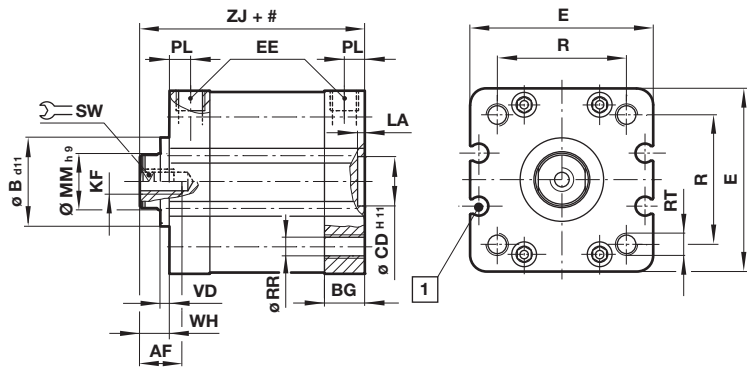
RA/192000/N4 – Cylinder with guiding
Torque moment
Side load

Dimensions
RA/192000/MX – Standard cylinder
With female piston rod thread

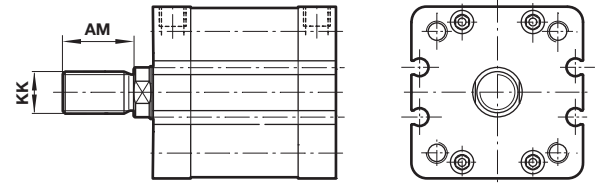

Dimensions
RA/192000/M – Standard cylinder
With male piston rod thread

Dimensions in mm
 Projection/First angle



Stroke
 1 M/50 switches can be mounted flush with the profile

ø	AF	AM	ø B d11	BG	ø CD H11	□ E	EE	KF	KK	LA	ø MM h9	PL
20	10	16	—	12	10	37	M 5	M6	M8x1,25	2,5	10	7
25	10	16	—	13	10	41	M 5	M6	M8x1,25	2,5	10	7
32	12	19	—	14,5	14	48	G 1/8	M8	M10x1,25	2,5	12	7,5
40	12	19	—	14,5	14	54,5	G 1/8	M8	M10x1,25	2,5	16	7,5
50	16	22	—	14	18	66	G 1/8	M10	M12x1,25	2,5	20	7,5
63	16	22	—	14	18	76	G 1/8	M10	M12x1,25	2,5	20	7,5
80	20	28	—	15,5	23	96	G 1/8	M12	M16x1,5	3	25	7,5
100	20	28	—	21,5	26	116	G 1/8	M12	M16x1,5	3	25	10,5
125	30	54	60	20,5	28	142	G 1/4	M20	M27x2	3	32	10,5
ø	□ R	ø RR	RT	SW	VD	WH	ZJ	kg at 0 mm	kg per 5 mm	Model		
20	22	4,3	M5	8	—	6	43	0,12	0,01	RA/192020/M./*		
25	26	4,3	M5	8	—	6	45	0,15	0,01	RA/192025/M./*		
32	32,5	5,3	M6	10	—	7	51	0,23	0,02	RA/192032/M./*		
40	38	5,3	M6	13	—	7	52	0,30	0,02	RA/192040/M./*		
50	46,5	6,8	M8	17	—	8	53	0,46	0,03	RA/192050/M./*		
63	56,5	6,8	M8	17	—	8	57	0,70	0,03	RA/192063/M./*		
80	72	8,6	M10	22	—	10	64	1,23	0,04	RA/192080/M./*		
100	89	8,6	M10	22	—	10	77	2,20	0,05	RA/192100/M./*		
125	110	10,6	M12	27	4	18	89	3,60	0,07	RA/192125/M./*		

* Please insert standard stroke length.

Cylinder variants

RA/192000/N2X – Cylinder with non-rotating piston rod
With female piston rod thread

RA/192000/N2 – Cylinder with non-rotating piston rod
With male piston rod thread

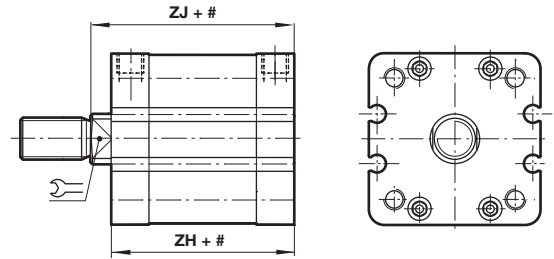
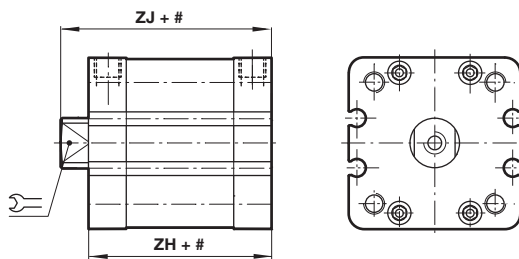

Stroke

ø	SW	ZH	ZJ	kg at 0 mm	kg per 5 mm	Model
20	8	47	53	0,12	0,01	RA/192020/N2./*
25	8	49	55	0,15	0,01	RA/192025/N2./*
32	10	54	61	0,23	0,02	RA/192032/N2./*
40	13	55	62	0,30	0,02	RA/192040/N2./*
50	16	55	63	0,46	0,03	RA/192050/N2./*
63	16	59	67	0,70	0,03	RA/192063/N2./*
80	21	64	74	1,23	0,04	RA/192080/N2./*
100	21	77	87	2,20	0,05	RA/192100/N2./*

Note: The basic length of the RA/192000/N2 version is slightly longer than the standard.

RA/192000/JMX
Cylinder with double ended piston rod
With female piston rod thread

RA/192000/JM
Cylinder with double ended piston rod
With male piston rod thread

Dimensions in mm
 Projection/First angle

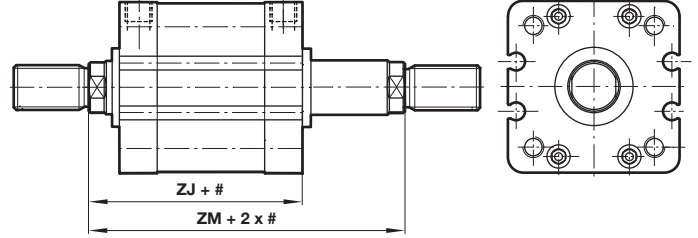
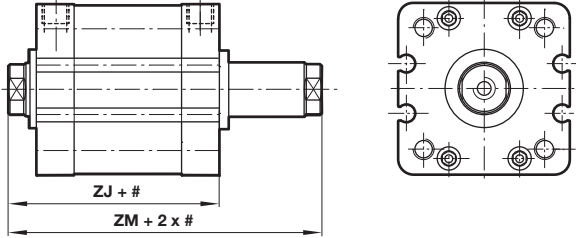

ø	ZJ	ZM	kg at 0 mm	kg per 5 mm	Model
20	43	49	0,15	0,01	RA/192020/JM./*
25	45	51	0,18	0,01	RA/192025/JM./*
32	51	58	0,28	0,02	RA/192032/JM./*
40	52	59	0,35	0,02	RA/192040/JM./*
50	53	61	0,52	0,03	RA/192050/JM./*
63	57	65	0,76	0,03	RA/192063/JM./*
80	64	74	1,30	0,04	RA/192080/JM./*
100	77	87	2,30	0,05	RA/192100/JM./*
125	89	107	3,75	0,07	RA/192125/JM./*

Stroke

* Please insert standard stroke length.

RA/192000/N4 – Cylinder with guiding

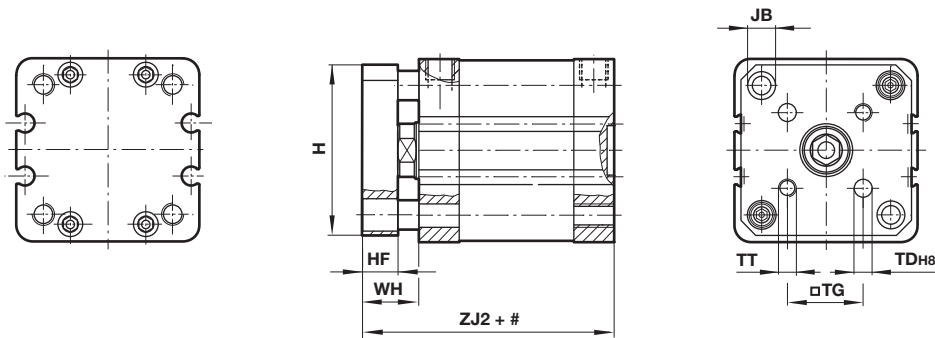

Stroke

ø	H	HF	ø JB	ø TDH8	... TG	TT	WH	ZJ2	kg at 0 mm	kg per 5 mm	Model
20	34	8	7,5	4	12	M4	14	51	0,17	0,01	RA/192020/N4./*
25	38	8	7,5	5	15,6	M5	14	53	0,23	0,01	RA/192025/N4./*
32	45	10	9	5	19,8	M5	17	61	0,33	0,02	RA/192032/N4./*
40	51	10	9	5	23,3	M5	17	62	0,45	0,02	RA/192040/N4./*
50	62,5	12	11	6	29,7	M6	20	65	0,65	0,03	RA/192050/N4./*
63	72	12	11	6	35,4	M6	20	69	0,95	0,03	RA/192063/N4./*
80	92	15	15	8	46	M8	25	79	1,70	0,04	RA/192080/N4./*
100	112	15	15	10	56,5	M10	25	92	3,10	0,05	RA/192100/N4./*

* Please insert standard stroke length.

RA/192000/N6 – Cylinder with external guiding

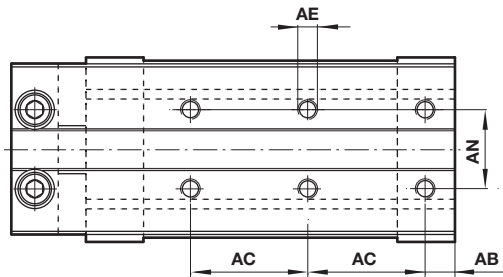
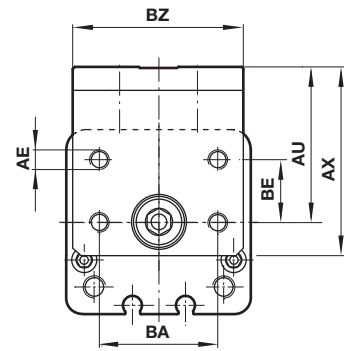
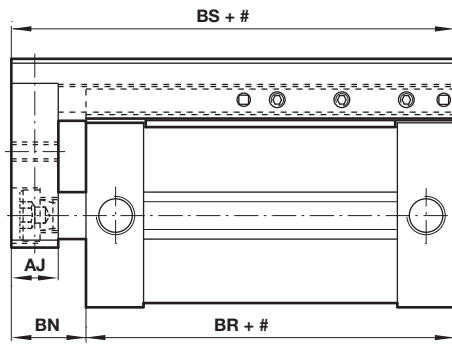
 Dimensions in mm
 Projection/First angle

Standard strokes 25, 50, 75 and 100 mm only

ø	AB	AC	AE	AJ	AN	AU	AX	BA	BE	BN	BR	BS	BZ	at 0 mm	per 5 mm	Model
25	7,5	30	M5	12	20	37,5	44	30	16	18	39	57	43,5	0,31 kg	0,09 kg	RA/192025/N6/*
32	7,5	30	M5	12	20	40,5	48,5	30	16	19	44	63	43,5	0,44 kg	0,12 kg	RA/192032/N6/*

* Please insert standard stroke length.

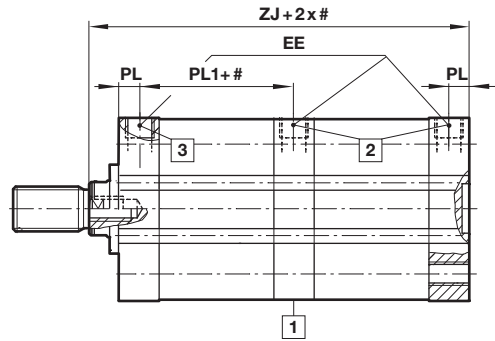
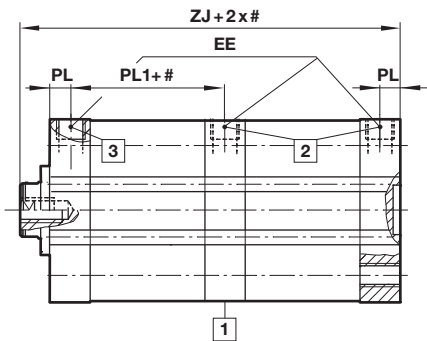
RA/192000/TMX – Tandem cylinder with female piston rod thread
RA/192000/TM – Tandem cylinder with male piston rod thread

ø	EE	PL	PL1	ZJ	kg at 0 mm	kg per 5 mm	Model
20	M5	7	25,5	68	0,21	0,01	RA/192020/TM./*
25	M5	7	26,5	71	0,26	0,01	RA/192025/TM./*
32	G 1/8	7,5	30	81	0,39	0,02	RA/192032/TM./*
40	G 1/8	7,5	31	83	0,51	0,02	RA/192040/TM./*
50	G 1/8	7,5	31	85	0,78	0,03	RA/192050/TM./*
63	G 1/8	7,5	36	94	1,21	0,03	RA/192063/TM./*
80	G 1/8	7,5	40	104	2,11	0,04	RA/192080/TM./*
100	G 1/8	10,5	45,5	122	3,68	0,05	RA/192100/TM./*

* Please insert standard stroke length.

Stroke

1 Exhaust port

Note: Do not cover this area!

2 Pressure »outstroke«

3 Pressure »instroke«

RA/192000/SMX – Multi position cylinder with female piston rod thread
RA/192000/SM – Multi position cylinder with male piston rod thread

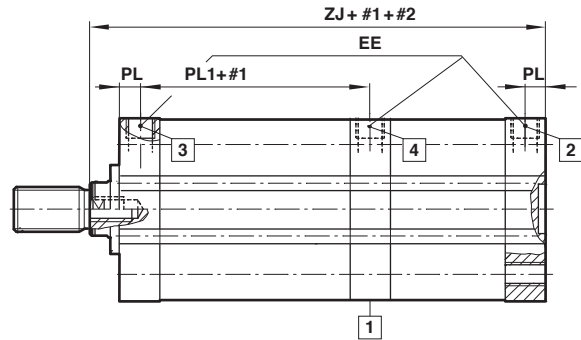
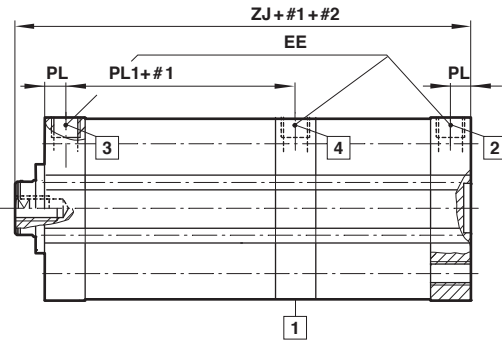
 Dimensions in mm
 Projection/First angle

ø	EE	PL	PL1	ZJ	kg at 0 mm	kg per 5 mm	Model
20	M5	7	25,5	68	0,21	0,01	RA/192020/SM./*
25	M5	7	26,5	71	0,26	0,01	RA/192025/SM./*
32	G 1/8	7,5	30	81	0,39	0,02	RA/192032/SM./*
40	G 1/8	7,5	31	83	0,51	0,02	RA/192040/SM./*
50	G 1/8	7,5	31	85	0,78	0,03	RA/192050/SM./*
63	G 1/8	7,5	36	94	1,21	0,03	RA/192063/SM./*
80	G 1/8	7,5	40	104	2,11	0,04	RA/192080/SM./*
100	G 1/8	10,5	45,5	122	3,68	0,05	RA/192100/SM./*

* Please insert standard stroke length.

 1 Exhaust port
 Note: Do not cover this area!

 #1 Stroke front cylinder
 #2 Stroke rear cylinder
 Note: Stroke (#1) > stroke (#2)

 2 Pressure »outstroke« rear cylinder
 3 Pressure »instroke«
 4 Pressure »outstroke« front cylinder

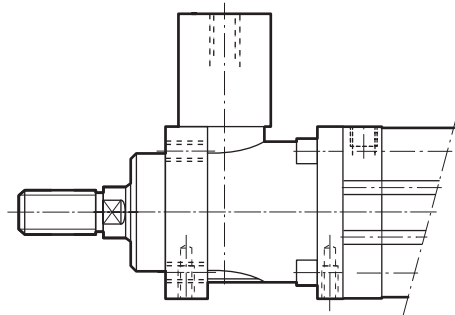
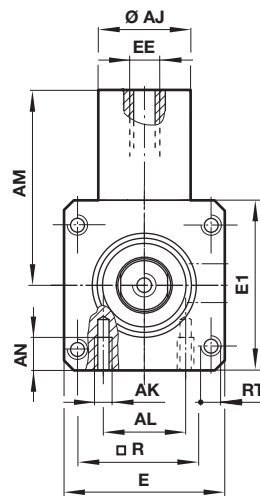
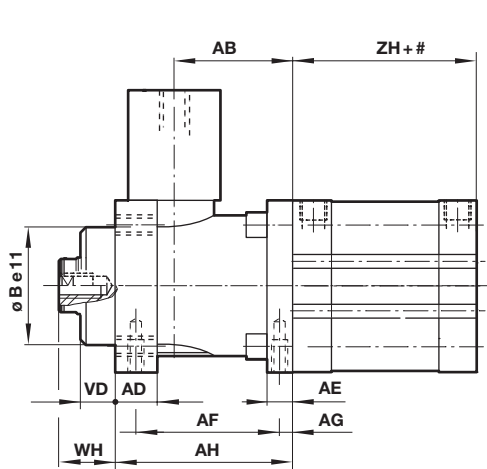
RA/192000/L4X – Cylinder with locking unit female piston rod thread
RA/192000/L4 – Cylinder with locking unit male piston rod thread

Stroke

ø	AB	AD	AE	AF	AG	AH	ø AJ	AK	AL	AM	AN	Be11	E	E 1
32	32	12	8	40	4,2	48	25	M5	16	49	8	30	48	50
40	35,5	12	10	46	4,5	55	24	M5	21	61,5	10	35	56	58
50	49	16	15	54	11,5	70	30	M6	24	75	12	40	68	70
63	49	15	15	55	7,5	70	38	M8	32	86	12	45	82	85
80	62	16	16	70	10	90	53	M8	44	119	16	45	100	105
100	65	18	16	70	10	92	48	M8	60	119	16	55	120	130
125	85	27	25	95	11	122	65	M10	75	140	20	60	140	150
ø	EE	R	RT	VD	WH	ZH	Locking force	kg at 0 mm	kg per 5 mm	Model				
32	M 5	32,5	M 6	10	16	44	600 N	0,53	0,02	RA/192032/L4./*				
40	G 1/8	38	M 6	10	18	45	1000 N	0,70	0,02	RA/192040/L4./*				
50	G 1/8	46,5	M 8	12	22	45	1500 N	1,26	0,03	RA/192050/L4./*				
63	G 1/8	56,5	M 8	12	20	49	2200 N	1,90	0,03	RA/192063/L4./*				
80	G 1/8	72	M 10	20	33	54	5000 N	3,80	0,04	RA/192080/L4./*				
100	G 1/8	89	M 10	23	38	67	5000 N	5,90	0,05	RA/192100/L4./*				
125	G 1/8	110	M 12	32	65	71	7000 N	10,10	0,07	RA/192125/L4./*				

* Please insert standard stroke length.

Mountings

Front or rear stud mounting A

Conforms to ISO 15552, type MX1

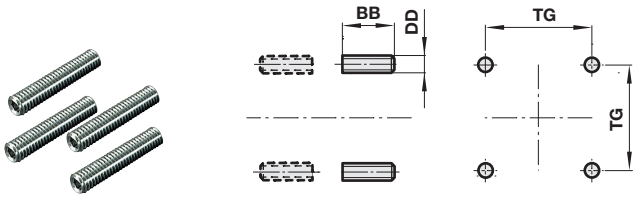

ø	BB	DD	TG	kg	Model (A)
32/40	17	M6	32,5/38	0,02	QM/8032/35
50/63	23	M8	46,5/56,5	0,05	QM/8050/35
80/100	28	M10	72/89	0,08	QM/8080/35
125	34	M12	110	0,14	QM/8125/35

Piston rod swivel AK

Dimensions in mm
Projection/First angle

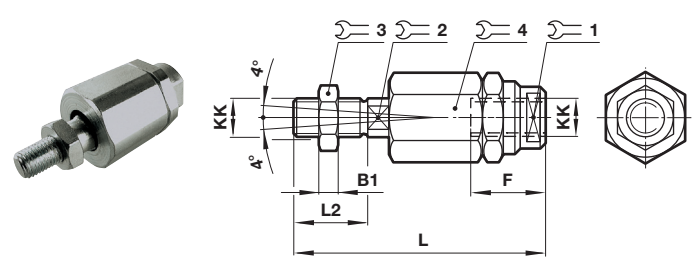

ø	KK	B1	F	L	L2	1 2 3 4				kg	Model (AK)
						1	2	3	4		
20/25	M8x1,25	4	18	55	16	10	7	13	17	0,05	QM/8020/38
32/40	M10x1,25	5	26	73	20	19	12	17	30	0,20	QM/8025/38
50/63	M12x1,25	6	26	77	24	19	12	19	30	0,20	QM/8040/38
80/100	M16x1,5	8	34	106	32	30	19	24	42	0,65	QM/8050/38
125	M27x2	13,5	40	147	54	40	24	41	55	1,70	QM/8125/38

Front flange B, Front flange G

Conforms to ISO 21 287 (ø 20 and 25 mm) and
ISO 15552 (ø 32 to 125 mm), type MF1 and MF2

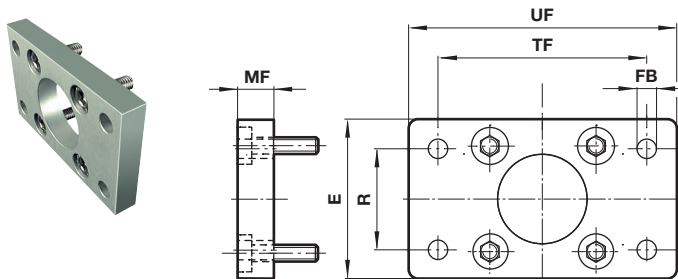

ø	E	ø FB	MF	R	TF	UF	kg	Model (B/G)
20	36	6,6	8	-	55	70	0,16	QA/192020/22
25	40	6,6	8	-	60	76	0,2	QA/192025/22
32	50	7	10	32	64	80	0,25	QA/8032/22
40	55	9	10	36	72	90	0,35	QA/8040/22
50	65	9	12	45	90	110	0,7	QA/8050/22
63	75	9	12	50	100	125	0,8	QA/8063/22
80	100	12	16	63	126	154	1,35	QA/8080/22
100	120	14	16	75	150	186	2,2	QA/8100/22
125	140	16	20	90	180	224	2,7	QM/8125/22

Foot C

Conforms to ISO 15552, type MS1

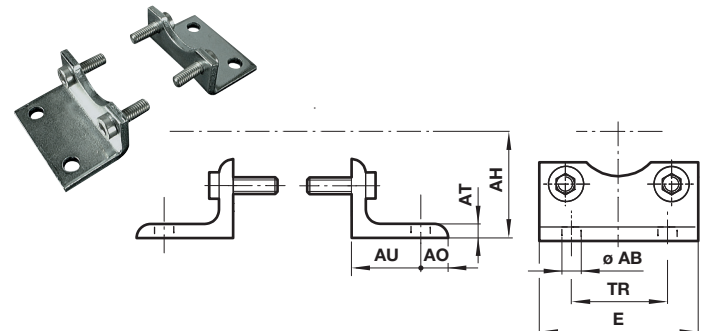

ø	ø AB	AH	AO	AT	AU	E	TR	kg	Model (C)
20	7	27	6	4	16	36	22	0,03	QM/192020/21
25	7	29	7	4	16	40	26	0,04	QM/192025/21
32	7	33,5	7	4	16	48	32	0,15	QA/192032/21
40	10	38	9	4	18	54,5	36	0,18	QA/192040/21
50	10	45	9	5	21	66	45	0,3	QA/192050/21
63	10	50	9	5	21	76	50	0,39	QA/192063/21
80	12	63	11	6	26	96	63	0,8	QA/192080/21
100	14,5	74	13	6	27	116	75	0,95	QA/192100/21
125	16	90	20	9	45	140	90	2,4	QM/8125/21

Rear clevis D
Conforms to ISO 15552, type MP2

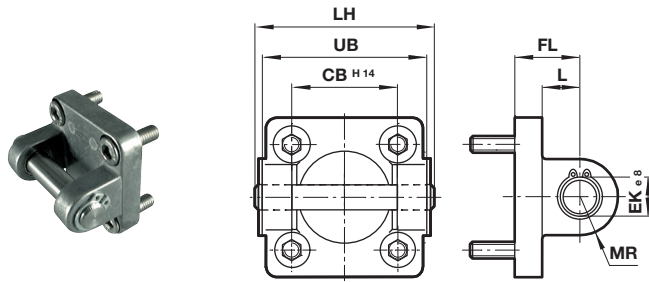

ø	CB H14	ø EK e8	FL	L	LH	MR	UB	kg	Model (D)
32	26	10	22	13	52	9	45	0,11	QA/8032/23
40	28	12	25	16	60	12	52	0,16	QA/8040/23
50	32	12	27	17	68	12	60	0,22	QA/8050/23
63	40	16	32	22	79	15	70	0,34	QA/8063/23
80	50	16	36	22	99	15	90	0,54	QA/8080/23
100	60	20	41	27	119	20	110	0,90	QA/8100/23
125	70	25	50	31	139	25	130	2,70	QM/8125/23

Rear clevis D2
Conforms to ISO 15552, type AB6

Dimensions in mm
Projection/First angle

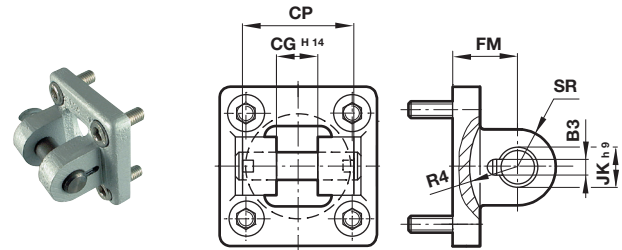

ø	B1 H14	B2	B3	ø EK h9	FL	R1	R2	kg	Model (D2)
32	14	34	3,3	10	22	11	17	0,20	QA/8032/42
40	16	40	4,3	12	25	12	20	0,23	QA/8040/42
50	21	45	4,3	16	27	14,5	22	0,36	QA/8050/42
63	21	51	4,3	16	32	18	25	0,55	QA/8063/42
80	25	65	4,3	20	36	22	30	0,90	QA/8080/42
100	25	75	4,3	20	41	22	32	1,45	QA/8100/42
125	37	97	6,3	30	50	30	42	2,7	QA/8125/42

Front or rear detachable trunnion FH
Conforms to VDMA 24562 part 2, type MT 5/6

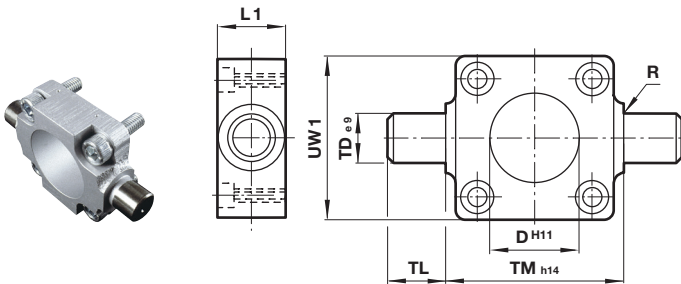

ø	ø D h11	L1	R	ø TD e9	TL	TM h14	UW1	kg	Model (FH)
32	30	16	1	12	12	50	45	0,20	QA/8032/34
40	35	20	1,6	16	16	63	55	0,38	QA/8040/34
50	40	24	1,6	16	16	75	65	0,60	QA/8050/34
63	45	24	1,6	20	20	90	75	1,10	QA/8063/34
80	45	28	1,6	20	20	110	100	1,90	QA/8080/34
100	55	38	2	25	25	132	120	3,50	QA/8100/34
125	60	50	2	25	25	160	145	6,50	QA/8125/34

Piston rod clevis F
Conforms to DIN ISO 8140
For cylinders with male piston rod thread order nut,
Type N2 separately

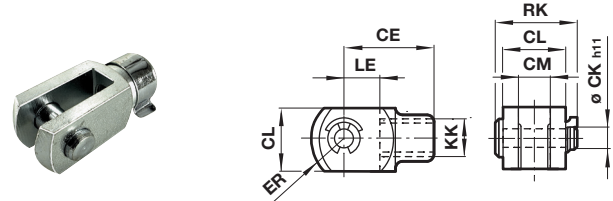

ø	KK	CE	ø CK h11	CL	CM	ER	LE	RK	kg	Model (F)
20/25	M8x1,25	32	8	16	8	13	16	22	0,06	QM/8020/25
32/40	M10x1,25	40	10	20	10	16	20	28	0,09	QM/8025/25
50/63	M12x1,25	48	12	24	12	19	24	32	0,13	QM/8040/25
80/100	M16x1,5	64	16	32	16	25	32	41,5	0,33	QM/8050/25
125	M27x2	110	30	55	30	45	54	62	1,35	QM/8125/25

Universal piston rod eye UF
Conforms to DIN ISO 8139
For cylinders with male piston rod thread order nut, Type N2 separately

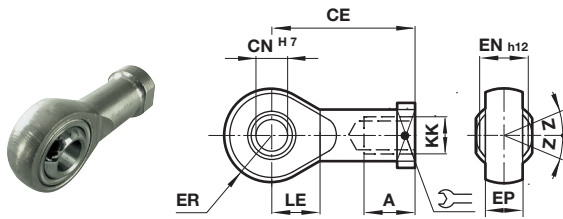

ø	Thread KK	AX	CE	ø CN H7	EN -0,1	ER	LE	Z	kg	Model (UF)
20/25	M8x1,25	16	36	8	12	11	13	5°	0,05	QM/8020/32
32/40	M10x1,25	20	43	10	14	14	15	13°	0,09	QM/8025/32
50/63	M12x1,25	22	50	12	16	16	17	13°	0,13	QM/8040/32
80/100	M16x1,5	28	64	16	21	21	22	15°	0,33	QM/8050/32
125	M27x2	51	110	30	37	35	36	15°	1,35	QM/8125/32

Rear eye R
Conforms to ISO 21 287 (ø 20 and 25 mm) and ISO 15552 (ø 32 to 125 mm), type MP4

Dimensions in mm
 Projection/First angle

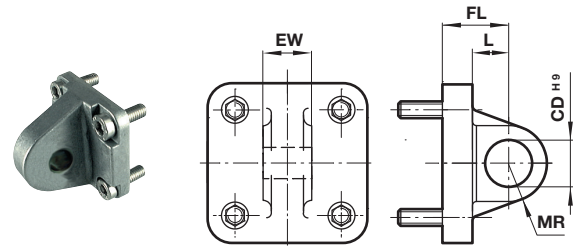

ø	øCDH9	EW	FL	L	MR	kg	Model (R)
20	8	15,8	20	14	8	0,02	QM/192020/27
25	8	15,8	20	14	8	0,03	QM/192025/27
32	10	25,8	22	13	9	0,09	QA/8032/27
40	12	27,8	25	16	12	0,11	QA/8040/27
50	12	31,7	27	17	12	0,17	QA/8050/27
63	16	39,7	32	22	15	0,24	QA/8063/27
80	16	49,7	36	22	15	0,37	QA/8080/27
100	20	59,7	41	27	20	0,59	QA/8100/27
125	25	69,7	50	33	25	3,2	QM/8125/27

Universal rear eye UR
Conforms to ISO 15552, type MP6

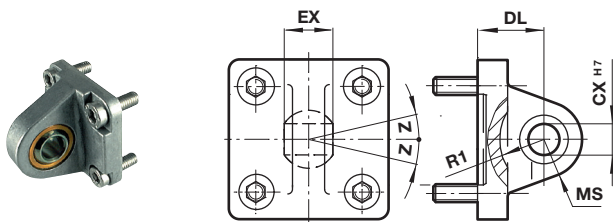

ø	ø CN H7	EN	ER	FL	R	Z	kg	Model (UR)
32	10	14	16	22	14,5	13°	0,15	QA/8032/33
40	12	16	18	25	18	13°	0,25	QA/8040/33
50	16	21	21	27	19	15°	0,40	QA/8050/33
63	16	21	23	32	24	15°	0,55	QA/8063/33
80	20	25	28	36	24	15°	0,90	QA/8080/33
100	20	25	30	41	29	15°	1,50	QA/8100/33
125	30	37	40	50	36	15°	2,70	QM/8125/33

Bracket hinge L2
For rear eye mounting R

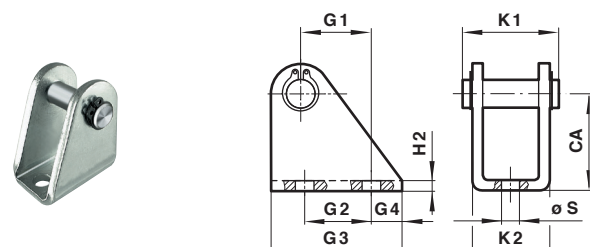

ø	CA	G1	G2	G3	G4	H2	K1	K2	ø S	kg	Model(L2)
20/25	30	16	20	32	6	4	29,5	24	6,6	0,08	QM/8020/44

Adjustable trunnion mounting UH Conforms to ISO 15552, type MT4

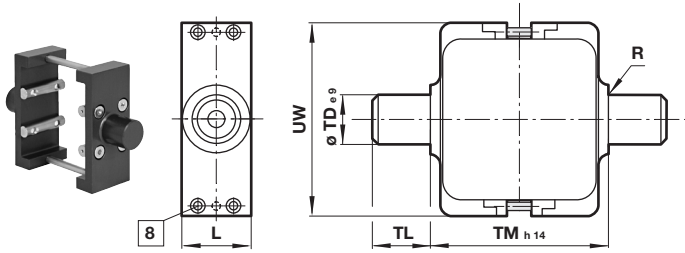

ø	L	R	ø De9	TL	TM h14	UW	Torque max. (Nm)	kg	Model (UH)
32	25	1	12	12	50	58	2	0,16	PQA/182032/40
40	28	1,6	16	16	63	65	3,5	0,35	PQA/182040/40
50	28	1,6	16	16	75	80	3,5	0,65	PQA/182050/40
63	36	1,6	20	20	90	96	5	0,85	PQA/182063/40
80	36	1,6	20	20	110	116	6	1,20	PQA/182080/40
100	48	2	25	25	132	140	6	2,30	PQA/182100/40
125	48	2	25	25	160	163	6	3,30	PQA/182125/40

Note: Style UH: It is most important that the locking screws which secure the mounting to the cylinder barrel are tightened to the torque figures shown in the table. For maximum energy input, consult our Technical Service.

Trunnion support S Conforms to ISO 15552, type AT4

Dimensions in mm
Projection/First angle

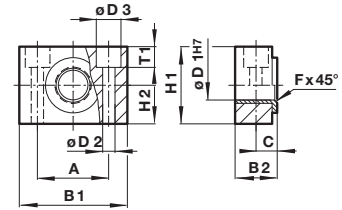
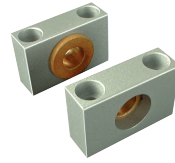

ø	A	B1	B2	C	ø D1h7	ø D1	ø D3	F x 45°	H1	H2	T1	kg	Model (S)
32	32	46	18	10,5	12	6,6	11	1	30	15,3	6,8	0,11	QA/8032/41
40/50	36	55	21	12	16	9	15	1,6	36	18	9	0,16	QA/8040/41
63/80	42	65	23	13	20	11	18	1,6	40	20	11	0,23	QA/8063/41
100/125	50	75	28,5	16	25	14	20	2	50	25	13	0,42	QA/8100/41

Nut N2

For cylinder with male piston rod thread

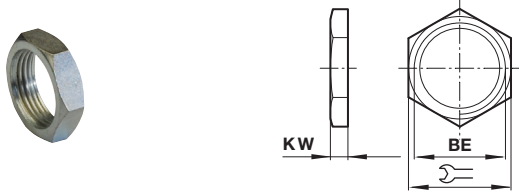

ø	BE	KW	⌀	kg	Model(N2)
20/25	M8x1,25	4	13	0,01	M/P1501/60
32/40	M10x1,25	5	17	0,01	M/P1501/89
50/63	M12x1,25	6	19	0,01	M/P1501/90
80/100	M16x1,5	8	24	0,02	M/P1501/91
125	M27x2	13,5	41	0,09	M/P1501/105

Wide hinge SW Conforms to ISO 15552, type AB7

Dimensions in mm
Projection/First angle

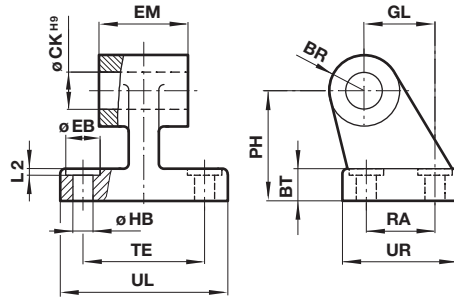

ø	CA	ø CK H9	ø D	H2	EM	G1	G2	G3	K1	K2	L1	R	ø S	kg	Model (SW)
32	32	10	11	7	25,5	21	18	31	38	50	1,6	10	6,6	0,05	M/P19493
40	36	12	11	9	27,5	24	22	35	41	54	1,6	11	6,6	0,07	M/P19494
50	45	12	15	11	31,5	33	30	45	50	65	1,6	13	9	0,14	M/P19495
63	50	16	15	12	39,5	37	35	50	52	67	1,6	15	9	0,18	M/P19496
80	63	16	18	14	49,5	47	40	60	66	84	2,5	15	11	0,28	M/P19497
100	71	20	18	15	59,5	55	50	70	76	94	2,5	19	11	0,42	M/P19498
125	90	25	20	20	70,5	70	60	90	94	124	3,2	22	14	2,70	M/P19499

Swivel hinge US Conforms to VDMA 24562 part 2

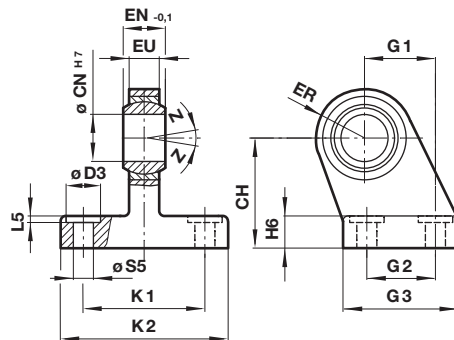

ø	CH	ø CN H7	ø D	EN -0,1	ER	EU	G1	G2	G3	H2	K1	K2	L1	ø S	Z	kg	Model (US)
32	32	10	11	14	16	10,5	21	18	31	10	38	51	1,6	6,6	13°	0,19	M/P40310
40	36	12	11	16	18	12	24	22	35	10	41	54	1,6	6,6	13°	0,24	M/P40311
50	45	16	15	21	21	15	33	30	45	12	50	65	1,6	9	13°	0,46	M/P40312
63	50	16	15	21	23	15	37	35	50	12	52	67	1,6	9	15°	0,59	M/P40313
80	63	20	18	25	28	18	47	40	60	14	66	86	2,5	11	15°	1,03	M/P40314
100	71	20	18	25	30	18	55	50	70	15	76	96	2,5	11	15°	1,4	M/P40315
125	90	30	20	37	40	25	70	60	90	20	94	124	3,2	14	15°	3,10	M/P71355

Assembly kit for four position cylinders

Dimensions in mm
Projection/First angle

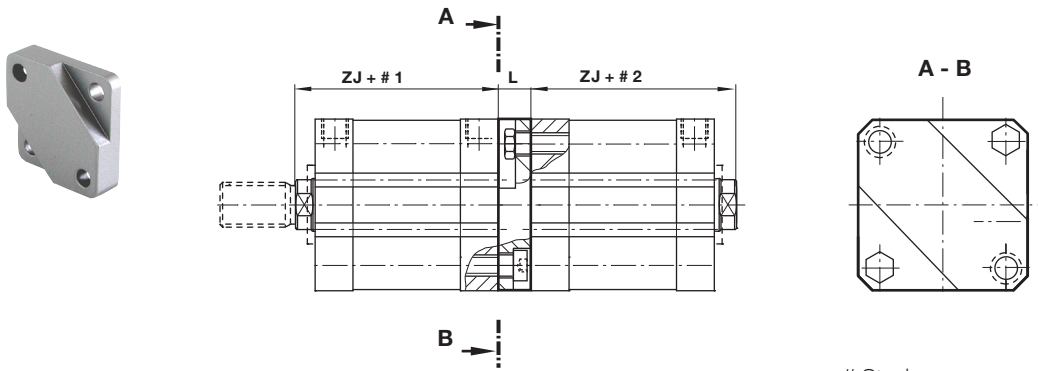

Stroke

ø	L	ZJ	max. Hublänge = #1 + #2	kg	Model
20	10	43	400	0,03	QA/192020/55
25	10	45	400	0,04	QA/192025/55
32	12,5	51	600	0,07	QA/192032/55
40	12,5	52	600	0,09	QA/192040/55
50	15	53	800	0,14	QA/192050/55
63	15	57	800	0,19	QA/192063/55
80	20	64	1000	0,35	QA/192080/55
100	20	77	1000	0,72	QA/192100/55
125	25	89	1000	1,03	QA/192125/55

Valve mounting kit

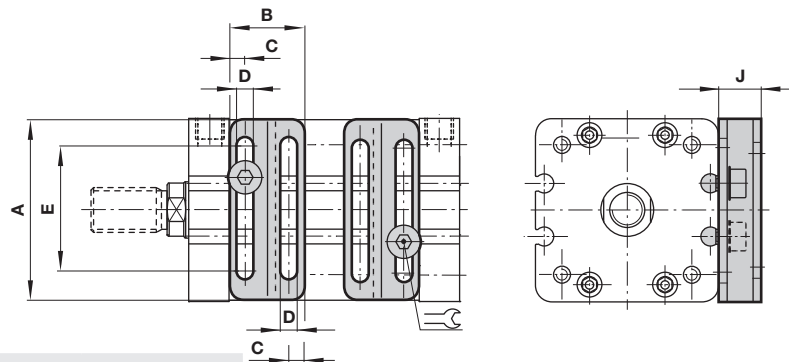

ø	A	B	C	D	E	F	G	H	J	kg	Model	
50/63	60	37	7	4,5	46	8,5	5,5	2	12	3	0,02	QA/180050/22/54
80/100/125	90	37	7	4,5	76	8,5	6,5	2	12	3	0,02	QA/180080/22/54

Groove key

Model: M/P72816

Weight: 0,01 kg



Groove cover M/P72725/1000

Model: M/P72725/1000

(length: 1m)

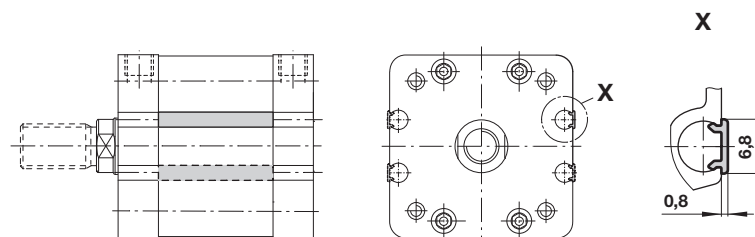

- > Magnetically operating reed switch - Round style
- > Suitable for all cylinder ranges with magnetic piston
- > Switches can be mounted flush with the delivered special adaptor
- > LED indicator on LSU models
- > Alternative variants allows a wide range of application



Technical features

Operation:

M/50/LSU Normally open with LED (yellow)

Switching voltage (Ub):

10 ... 240 V a.c./170 V d.c.

Switching voltage output:

Ub - 2,7 V

Switching current

(see graph overleaf):

0,18 A max.

Switching power:

10 W/10 VA max.

Contact resistance:

150 mΩ

Response time:

1,8 ms

Operating temperature:

-25 ... +80 °C (-13 ... +176 °F)

High temperature version:

+150 °C max. (+302 °F)

Protection rating (EN 60529):

IP66

Shock resistance:

50 g (during 11 ms)

Vibration resistance:

35 g (at 2000 Hz)

Cable type:

2 x 0,25: PVC, PUR or silicone

3 x 0,25 PVC

Cable length:

2, 5 or 10 m

Electromagnetic compatibility

according to:

EN 60947-5-2

Materials:

Body: plastic

Cable: see table below

Technical data - Reed switches - additional information see data sheet en 4.3.005

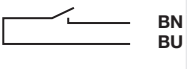
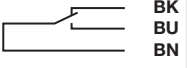
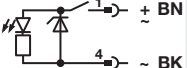
Symbol	Voltage		Current maximum (mA)	Function	Operating temperature (°C)	LED	Protection class	Plug	Cable length (m)	Cable type	Weight (g)	Model
	(V a.c.)	(V d.c.)										
	10 ... 240	10 ... 170	180	Normally open	-25 ... +80	•	IP 66	—	2, 5 or 10	PVC 2x0,25	37	M/50/LSU/*V
	10 ... 240	10 ... 170	180	Normally open	-25 ... +80	•	IP 66	—	5	PUR 2x0,25	37	M/50/LSU/5U
	10 ... 240	10 ... 170	180	Normally open	-25 ... +150	—	IP 66	—	2	Silicon 2x0,25	37	TM/50/RAU/2S
	10 ... 240	10 ... 170	180	Changeover	-25 ... +80	—	IP 66	—	5	PVC 3x0,25	37	M/50/RAC/5V
	10 ... 60	10 ... 60	180	Normally open	-25 ... +80	•	IP 66	M8x1	0,3	PVC 3x0,25	16	M/50/LSU/CP*1)
	10 ... 60	10 ... 60	180	Normally open	-25 ... +80	•	IP 66	M12x1	0,3	PVC 3x0,25	16	M/50/LSU/CC*1)

* Insert cable length; *1) Plug-in connector see page 12

Dimensions

M/50/LSU/*V, M/50/LSU/5U,
TM/50/RAU/2S
Cable length L = 2, 5 or 10 m

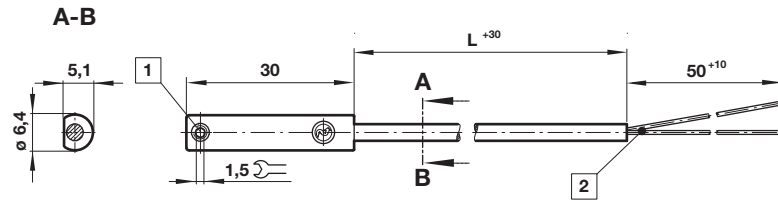

Dimensions in mm
Projection/First angle



M/50/RAC/5V
Cable length L = 5 m

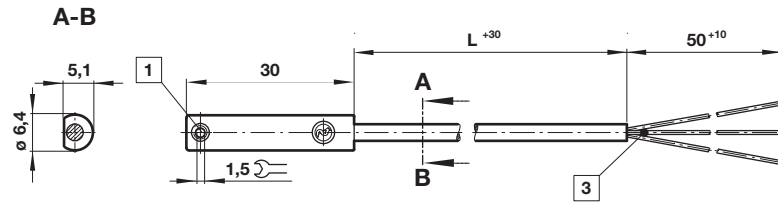

M/50/LSU/CP
M/50/LSU/CC

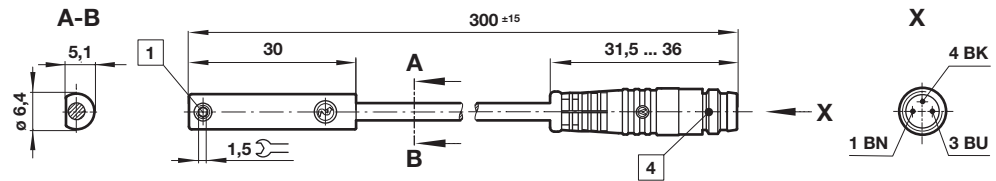

- 1 Fixing screw
- 2 + BN = brown; - BU = blue (output)
- 3 - BK = black; + BN = brown; - BU = blue

- 4 Version CP: Plug M8 x 1, color code: BK = +; BN = -; BU = output
Version CC: Plug M12 x 1, color code: BK = +; BN = -; BU = output

Accessories

Plug-in connector cable with nut



Outer cover	Cable length (m)	Weight (kg)	Connector	Connector
PVC 3 x 0,25	5	0,18	M8 x 1 straight connector	M/P73001/5
PUR 3 x 0,25	5	0,18	M8 x 1 straight connector	M/P73002/5
PVC 3 x 0,25	5	0,18	angled connector 90°	M/P34615/5
PUR 3 x 0,25	5	0,18	angled connector 90°	M/P34596/5
PUR 3 x 0,34	5	0,21	M12 x 1 straight connector	M/P34594/5

- > Magnetically operated switch, solid state - round style
- > IO-Link version available
- > Suitable for all cylinder ranges with magnetic piston
- > Switches can be mounted flush in all profile cylinders
- > Reliable switching with a very fast reponse time
- > Particularly suited for use in high levels of vibration
- > LED indicator as standard
- > UL listed



Technical features

Operation:

PNP / NPN (see table)
Output with LED (yellow)
Normally open (standard)

Switching voltage (U_b):

10 ... 30 V d.c.
("supply class 2" acc. to cULus)

Voltage drop at output:

< 2,5 V

Residual current:

< 0,5 mA

Switching current

(see graph):

100 mA max. (standard)
300 mA max. (M/50/EHP)

Switching power:

3,0 W max. (standard)
9,0 W max. (M/50/EHP)

Response time:

< 0,1 ms (standard)
< 5 ms (M/50/IOP)

Operating frequency:

1 kHz (standard)
200 Hz (M/50/IOP)

Responsiveness:

2,8 mT

Hysteresis:

0,5 ... 1,5 mT
0,2 mT (M/50/IOP)

Repeatability:

< 0,1 mT

Protection rating (EN 60529):

IP67 (standard)
IP68 (M/50/EAP/5U, M/50/EHP/5U)

Operating temperature:

-40 ... +80 °C (-40 ... 176 °F)
(permanently fixed cable)
-25 ... +80 °C (-13 ... 176 °F)
(moving cable)

Cable type:

PVC 3 x 0,14 mm² (standard)
PUR 3 x 0,14 mm² (M/50/E*P/*U
and all variants with connector)

Cable length:

2, 5 and 10 m

Electromagnetic compatibility

according to:
EN 60947-5-2

Materials:

Housing: plastic
Thread insert: brass
Set screw: stainless steel
Cable: see table below

Mounting type:

Flush mountable

Technical data - Solid state - additional information see data sheet en 4.3.007

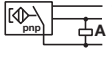
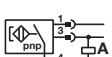
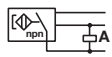
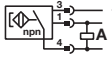
Symbol	Voltage (V DC)	Current maximum (mA)	Function	IO-Link *1)	Operating temperature (°C)	LED	Protection class	Connector	Cable length (m)	Cable type	Weight (g)	Model
	10 ... 30	100	PNP		-40 ... +80	•	IP67	---	2	PVC 3 x 0,14	23	M/50/EAP/2V
	10 ... 30	100	PNP		-40 ... +80	•	IP67	---	5	PVC 3 x 0,14	56	M/50/EAP/5V
	10 ... 30	100	PNP		-40 ... +80	•	IP67	---	10	PVC 3 x 0,14	102	M/50/EAP/10V
	10 ... 30	100	PNP / NPN	•	-40 ... +80	•	IP67	---	5	PVC 3 x 0,14	56	M/50/IOP/5V
	10 ... 30	100	PNP		-40 ... +80	•	IP68	---	5	PUR 3 x 0,14	56	M/50/EAP/5U
	10 ... 30	100	PNP		-40 ... +80	•	IP67	---	10	PUR 3 x 0,14	102	M/50/EAP/10U
	10 ... 30	300	PNP		-40 ... +80	•	IP67	---	2	PVC 3 x 0,14	23	M/50/EHP/2V
	10 ... 30	300	PNP		-40 ... +80	•	IP67	---	5	PVC 3 x 0,14	56	M/50/EHP/5V
	10 ... 30	300	PNP		-40 ... +80	•	IP67	---	10	PVC 3 x 0,14	102	M/50/EHP/10V
	10 ... 30	300	PNP		-40 ... +80	•	IP68	---	5	PUR 3 x 0,14	56	M/50/EHP/5U
	10 ... 30	100	PNP		-40 ... +80	•	IP67	M8 x 1	0,3	PUR 3 x 0,14	7	M/50/EAP/CP
	10 ... 30	100	PNP / NPN	•	-40 ... +80	•	IP67	M8 x 1	0,3	PUR 3 x 0,14	7	M/50/IOP/CP
	10 ... 30	100	PNP		-40 ... +80	•	IP67	M12 x 1	0,3	PUR 3 x 0,14	16	M/50/EAP/CC
	10 ... 30	100	PNP		-40 ... +80	•	IP67	M12 x 1	2	PUR 3 x 0,14	35	M/50/EAP/CC/2
	10 ... 30	100	PNP / NPN	•	-40 ... +80	•	IP67	M12 x 1	0,3	PUR 3 x 0,14	16	M/50/IOP/CC
	10 ... 30	300	PNP		-40 ... +80	•	IP67	M8 x 1	0,3	PUR 3 x 0,14	7	M/50/EHP/CP
	10 ... 30	100	NPN		-40 ... +80	•	IP67	---	2	PVC 3 x 0,14	23	M/50/EAN/2V
	10 ... 30	100	NPN		-40 ... +80	•	IP67	---	5	PVC 3 x 0,14	56	M/50/EAN/5V
	10 ... 30	100	NPN		-40 ... +80	•	IP67	---	10	PVC 3 x 0,14	102	M/50/EAN/10V
	10 ... 30	100	NPN		-40 ... +80	•	IP67	M8 x 1	0,3	PUR 3 x 0,14	7	M/50/EAN/CP

Color code: see next page

*1) IO-Link functionality: see next page

IO-Link Switch conforming to IEC 61131-9

Properties and Functionality	M/50/EAP, M/50/EAN M/50/EHP	M/50/IOP
Operating Mode	Standard	Standard
Power LED		•
LED sensor signal	•	•
Normally open (delivery status)	•	•
Normally closed		○
Delay mode		○
Installation aid		•
Temperature measurement		•
Detection counter		•
Teach functionality		•
Responsiveness adjustment		•

Note: IODD for the M/50/IOP switches available on the Norgren homepage.
<https://www.norgren.com/uk/en/technical-support/software>

• = included

○ = optional (manufacture pre-setting required)

Switching current and switching voltage

M/50/EAP, M/50/EAN, M/50/IOP

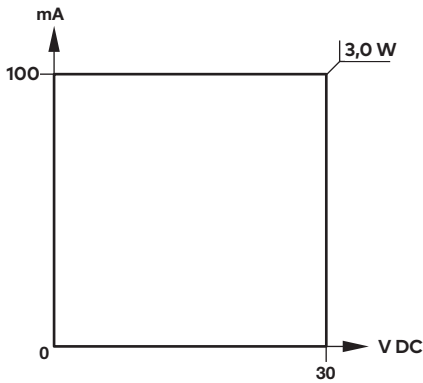

M/50/EHP

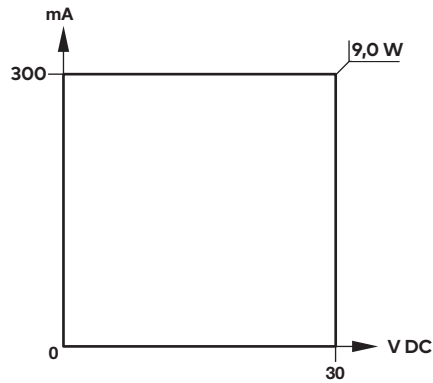

Dimensions

M/50/EAP/*V,
M/50/EAN/*U,
M/50/IOP/5V,
M/50/EHP/*V,
M/50/EHP/5U,
M/50/EAN/*V
Cable length L = 2, 5 or 10 m

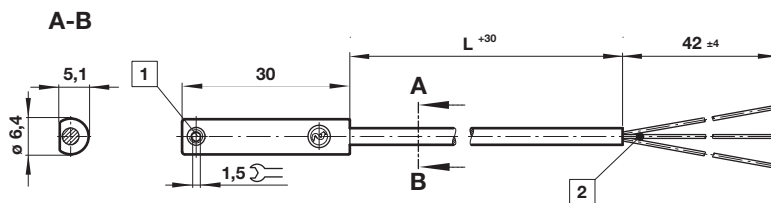

Dimensions in mm
Projection/First angle



M/50/EAP/CP,
M/50/EAN/CP,
M/50/IOP/CP,
M/50/EHP/CP

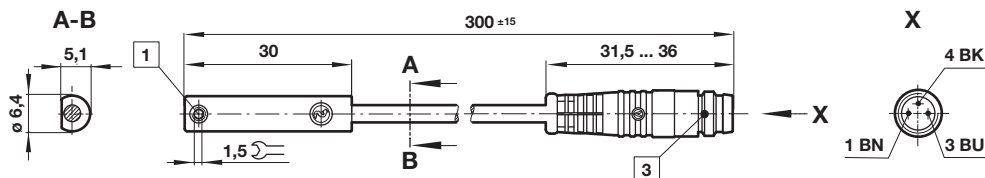

M/50/EAP/CC,
M/50/IOP/CC,
M/50/EHP/CC

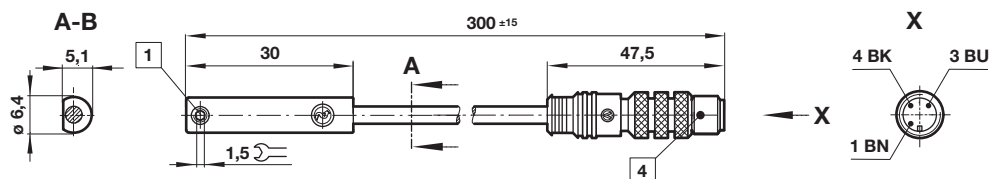

1 Fixing screw

2 Color code: BK = black (output); BN = brown (+); BU = blue (-)

3 Connector M8 x 1; 1 BN = +; 3 BU = -; 4 BK = output

4 Connector M12 x 1; 1 BN = +; 3 BU = -; 4 BK = output

Accessories

Plug-in connector cable with nut



Dimensions in mm
Projection/First angle



Outer cover	Cable length (m)	Weight (kg)	Connector	Connector
PVC 3 x 0,25	5	0,18	M8 x 1 straight connector	M/P73001/5
PUR 3 x 0,25	5	0,18	M8 x 1 straight connector	M/P73002/5
PVC 3 x 0,25	5	0,18	angled connector 90°	M/P34615/5
PUR 3 x 0,25	5	0,18	angled connector 90°	M/P34596/5
PUR 3 x 0,34	5	0,21	M12 x 1 straight connector	M/P34594/5

Warning

These products are intended for use in industrial compressed air systems only. Do not use these products where pressures and temperatures can exceed those listed under »**Technical features/data**«.

Before using these products with fluids other than those specified, for non-industrial applications, life-support systems or other applications not within published specifications, consult Norgren GmbH.

Through misuse, age, or malfunction, components used in fluid power systems can fail in various modes.

The system designer is warned to consider the failure modes of all component parts used in fluid power systems and to provide adequate safeguards to prevent personal injury or damage to equipment in the event of such failure.

System designers must provide a warning to end users in the system instructional manual if protection against a failure mode cannot be adequately provided.

System designers and end users are cautioned to review specific warnings found in instruction sheets packed and shipped with these products.