

B68G - Olympian Plus plug-in system

Filter/regulator



- > Port size: 3/4" ... 1 1/2" (ISO G/PTF)
- > High efficiency water removal
- > Diaphragm and balanced valve design ensure good regulation characteristics
- > Non-rising adjusting knob has snap-action lock
- > Standard options include non-relieving models, manual drain and alternative pressure ranges



Technical features

Medium:

Compressed air only

Maximum operating pressure:

17 bar (246 psi)

Pressure range:

Standard

0,4 ... 8 bar (5 ... 116 psi)

Optional

0,3 ... 4 bar (4 ... 58 psi),

0,7 ... 17 bar (10 ... 246 psi)

Flow:

240 dm³/s; Port size: G1

Operating pressure: 6,3 bar (91 psi)

Δp: 0,5 bar (7 psi)

Filter element: 40 μm

Filter element:

40 μm, optional 5 μm

Port sizes:

3/4", 1", 1 1/4" or 1 1/2"

Gauge port:

1/8 PTF with PTF main ports

Rc1/8 with ISO G main ports

Drain:

Manual or automatic

Automatic drain conditions:

Pressure to close drain:

> 0,3 bar (4.3 psi)

Pressure to open drain:

< 0,2 bar (2.9 psi)

Minimum air flow to close drain:

0,6 dm³/s (1.3 scfm)

Relieving:

With (standard)

Non-relieving (optional)

Bowl size:

0,5 litre (17 fluid oz standard);

1 litre (34 fluid oz optional)

Standard compliances:

II 2G Ex h IIC T6 Gb

II 2D Ex h IIIC T85° Db

Ambient/Media temperature:

-20° ... +80°C (-4° ... +176°F)

Version with gauge:

-20° ... +65°C (-4° ... +149°F)

Air supply must be dry enough to avoid ice formation at temperatures below +2°C (+35°F).

Materials:

Body, bowl and yoke: Aluminium

Liquid level indicator: Pyrex

Filter element: Sintered plastic

Adjusting knob: Acetal resin

Elastomers: NBR

Technical data, standard models

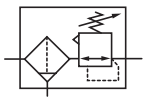
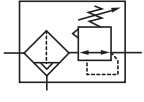
Symbol	Port size	Size	Pressure range (bar)	Filter element (μm)	Drain	Weight (kg)	Model
	G3/4	—	0,4 ... 8	40	Manual	3,29	B68G-6GK-MR3-RLN
	G1	Basic	0,4 ... 8	40	Manual	3,29	B68G-8GK-MR3-RLN
	G1 1/4	—	0,4 ... 8	40	Manual	3,35	B68G-AGK-MR3-RLN
	G1 1/2	—	0,4 ... 8	40	Manual	3,35	B68G-BGK-MR3-RLN
	Without yoke	—	0,4 ... 8	40	Manual	2,30	B68G-NNK-MR3-RLN
	G3/4	—	0,4 ... 8	40	Automatic	3,29	B68G-6GK-AR3-RLN
	G1	Basic	0,4 ... 8	40	Automatic	3,29	B68G-8GK-AR3-RLN
	G1 1/4	—	0,4 ... 8	40	Automatic	3,35	B68G-AGK-AR3-RLN
	G1 1/2	—	0,4 ... 8	40	Automatic	3,35	B68G-BGK-AR3-RLN
	Without yoke	—	0,4 ... 8	40	Automatic	2,30	B68G-NNK-AR3-RLN

Option selector

Version	Substitute
Long bowl (1 litre)	E
Standard bowl (0,5 litre)	G
Port size	Substitute
3/4"	6
1"	8
1 1/4"	A
1 1/2"	B
Without yoke	N
Threads form	Substitute
PTF or without yoke (N in 6th position), drain and gauge threads = PTF	A
ISO G parallel (standard)	G
Without yoke (N in 6th position), drain and gauge threads = ISO Rc	N
Adjustment	Substitute
Knob (standard)	K
T-bar (0,7 ... 17 bar (10 ... 246 psi))	T
Drain	Substitute
Automatic	A
Manual	M

B68★-★ ★★-★ ★★-★ ★★

Gauge	Substitute
With	G
Without (standard)	N
Pressure range (bar)*1)	Substitute
0,4 ... 8 (standard)	L
0,3 ... 4	F
0,7 ... 17	S *2)
Diaphragm	Substitute
Relieving (standard)	R
Non-relieving	N
Filter element	Substitute
5 µm	1
40 µm (standard)	3
Bowl	Substitute
0,5 l with liquid level indicator	R
1 l with liquid level indicator	U *3)
0,5 l no liquid level indicator	M
1 l no liquid level indicator	C *3

*1) Outlet pressure can be adjusted to pressures in excess of and less than, those specified. Do not use these units to control pressures outside of the specified ranges.

*2) Units with 17 bar (246 psi) outlet pressure range are available only with the T-bar adjustment; therefore substitute T at the 7th digit and S at the 9th position.



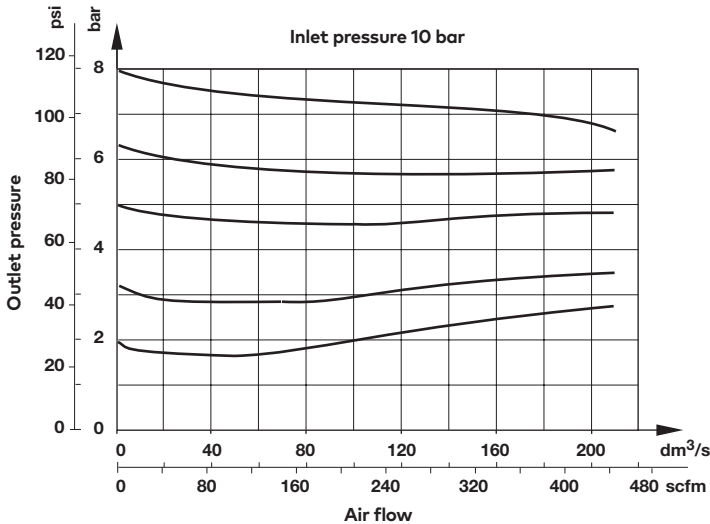



*3) Units with 1 litre bowl are available only with 'E' version only; therefore substitute E at the 4th digit and U or C at the 9th position.

Flow characteristics
**Port size 1", 40 µm element,
Range 0,4 ... 8 bar**





Accessories, service kit and gauges



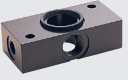

Accessories

	Single yoke	Double yoke	End connector kit	Single yoke non threads	3/2 Shut-off valve Threaded inlet only	Threaded outlet only	Bracket mounting
							
Thread	5	5	2	5			1
G3/4	Y68A-6GN-N1N	Y68A-6GN-N2N	5524-55	74785-98	T68H-6GB-B2N	T68H-6GC-B2N	18-001-979
G1	Y68A-8GN-N1N	Y68A-8GN-N2N	5524-52		T68H-8GB-B2N	T68H-8GC-B2N	18-001-979
G1 1/4	Y68A-AGN-N1N	Y68A-AGN-N2N	5523-52		T68H-AGB-B2N	T68H-AGC-B2N	18-001-978
G1 1/2	Y68A-BGN-N1N	Y68A-BGN-N2N	5523-93		T68H-BGB-B2N	T68H-BGC-B2N	18-001-972
3/4 PTF	Y68A-6AN-N1N	Y68A-6AN-N2N	5524-53		T68H-6AB-B2N	T68H-6AC-B2N	18-001-979
1 PTF	Y68A-8AN-N1N	Y68A-8AN-N2N	5524-50		T68H-8AB-B2N	T68H-8AC-B2N	18-001-979
1 1/4 PTF	Y68A-AAN-N1N	Y68A-AAN-N2N	5523-50		T68H-AAB-B2N	T68H-AAC-B2N	18-001-978
1 1/2 PTF	Y68A-BAN-N1N	Y68A-BAN-N2N	5523-95		T68H-BAB-B2N	T68H-BAC-B2N	18-001-972

Service kit

Nut	Tamper resistant cap & seal wire	Porting block	Padlock with two keys
			
4	3		
5520-89	4355-51	18-026-986 (G1/4 & G1/2)	0613633 (brass)

Manual drain	Automatic drain
	
5 µm B68G-KITM05R	B68G-KITA05R
40 µm B68G-KITM40R	B68G-KITA40R

Gauges

Center back connection, white face (full technical specification see datasheet 8.900.900)



6

Pressure range

bar *1	MPa	psi	Ø	Thread size	Model
0 ... 4	0 ... 0,4	0 ... 58	50 mm	R1/8	18-015-011
0 ... 10	0 ... 1	0 ... 145	50 mm	R1/8	18-015-013
0 ... 25	0 ... 2,5	0 ... 362	50 mm	R1/8	18-015-014

*1) primary scale

Center back connection, black face for North America (full technical specification see datasheet 8.900.900)



6

Pressure range

psig *1	bar	MPa	Ø	Thread size	Model
0 ... 60	0 ... 4	0 ... 0,4	2" (50 mm)	1/8 NPT	18-015-202
0 ... 160	0 ... 11	0 ... 1,1	2" (50 mm)	1/8 NPT	18-015-204
0 ... 400	0 ... 28	0 ... 2,8	2" (50 mm)	1/8 NPT	18-015-206

*1) primary scale

Dimensions

Dimensions in mm
Projection/First angle

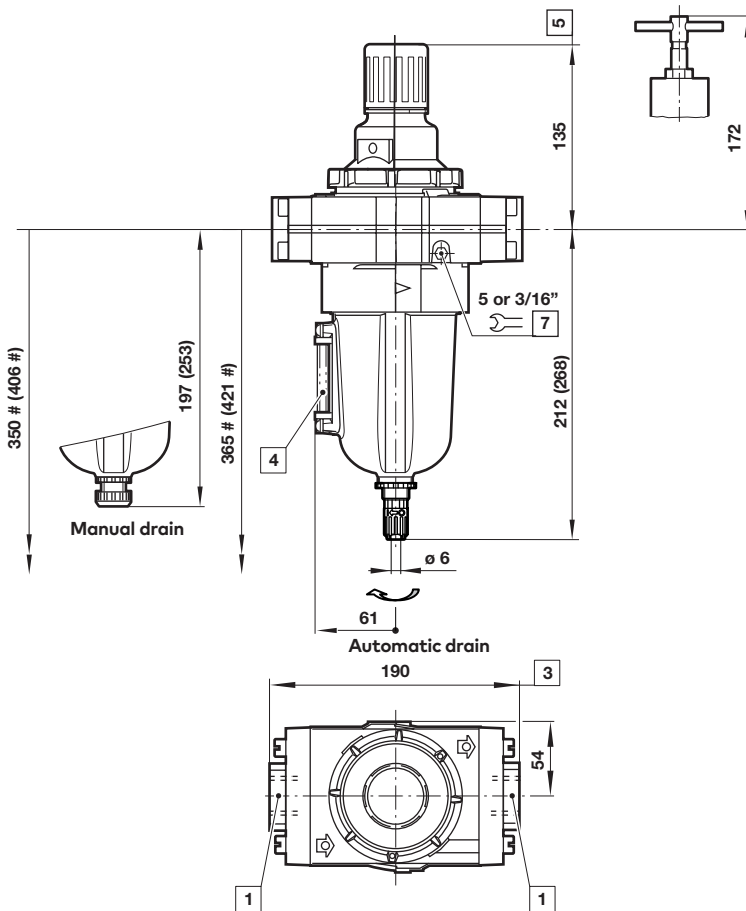

Minimum clearance required to remove bowl

() values for 1 litre bowl

1 Main ports 3/4", 1", 1 1/4" or 1 1/2"

3 Plus 10 mm for ports 1 1/4" or 1 1/2"

4 Sight glass

5 Reduces by 4 mm with knob in locked position

7 Gauge port 1/8"

Single yoke with bracket

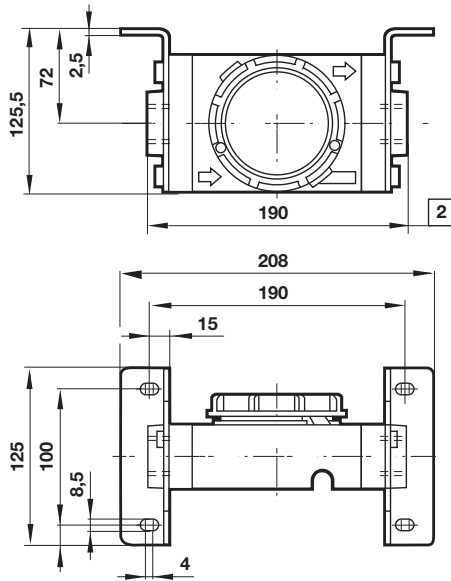

1 For 1 1/4" and 1 1/2" ported yokes add 10 mm

Double yoke with bracket

Dimensions in mm
Projection/First angle

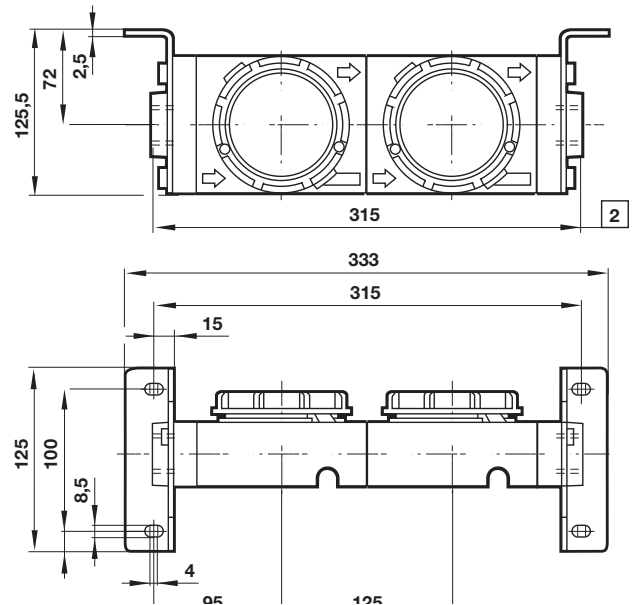

1 For 1 1/4" and 1 1/2" ported yokes add 10 mm

3/2 Shut-off valve

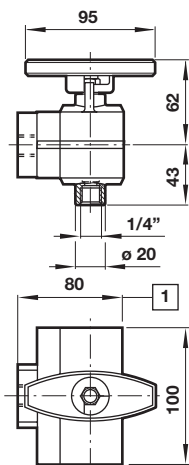

1 For 1 1/2" ported yokes add 5 mm

Porting block

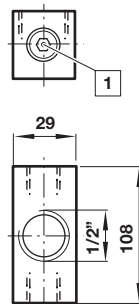

1 Two additional plugged G1/4 ports

Warning

These products are intended for use in industrial compressed air systems only. Do not use these products where pressures and temperatures can exceed those listed under »**Technical features/data**«.

Before using these products with fluids other than those specified, for non-industrial applications, life-support systems or other applications not within published specifications, consult Norgren.

Through misuse, age, or malfunction, components used in fluid power systems can fail in various modes.

The system designer is warned to consider the failure modes of all component parts used in fluid power systems and to provide adequate safeguards to prevent personal injury or damage to equipment in the event of such failure.

System designers must provide a warning to end users in the system instructional manual if protection against a failure mode cannot be adequately provided.

System designers and end users are cautioned to review specific warnings found in instruction sheets packed and shipped with these products.